

# User Manual

## Mu7

Noise Cancelling Over-ear Wireless Headphones

Design by Ross Lovegrove



## **Introduction**

Thank you for purchasing KEF Mu7.

Mu7 combines excellence in three fields – audio quality, user experience and aesthetics. Mu7 gives you the opportunity to bring the listening room everywhere you go.

Please read this user manual fully before using Mu7.

## In the Box\*

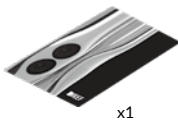
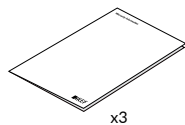
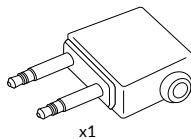
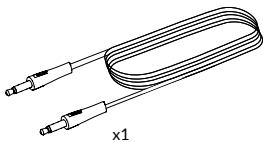
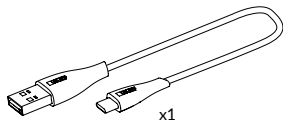
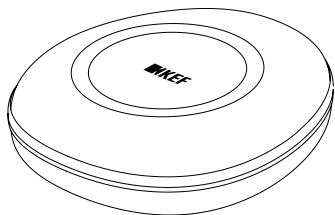

\*Contents vary by region.

# Headphones Overview

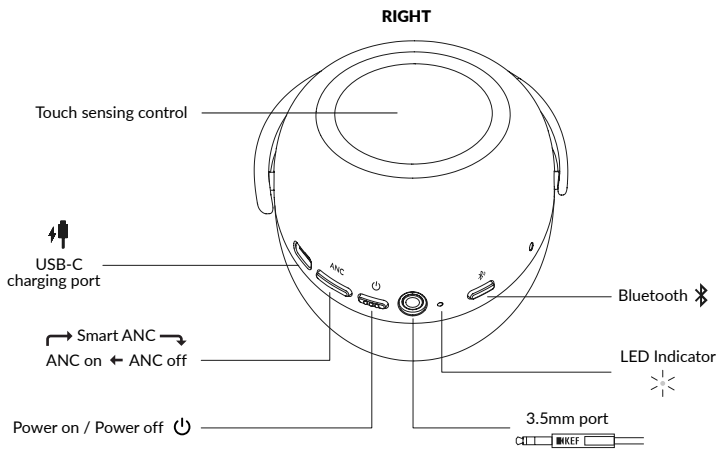

## Get Started

### Wear the Mu7 headphones

1. Extend and adjust the Mu7 headband to properly fit your head.

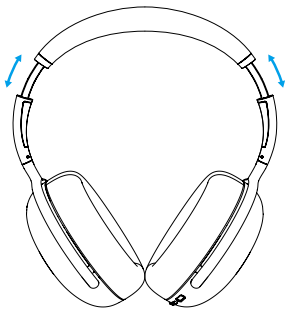

2. Put on the Mu7 with the earpads fitting snugly over your ears.

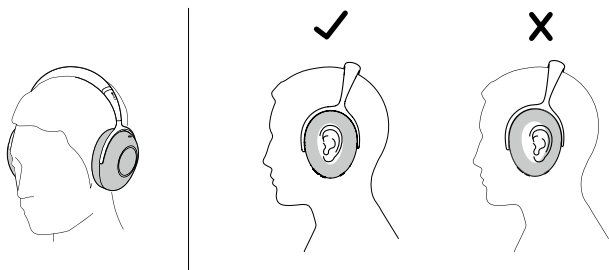

# Get Started

## Pair with Bluetooth device

### First time to pair Mu7 headphones with your Bluetooth device

1. Long press “Power” button to turn on Mu7, and the LED will turn solid white briefly.
2. In one second, Mu7 will directly enter Bluetooth pairing mode and the LED will start blinking blue.
3. Voice prompt “Ready to pair” can be heard.
4. Go to the Bluetooth setting page of your device and select “KEF Mu7” from your Bluetooth device list.
5. Once Mu7 is paired, the LED will turn to solid white.

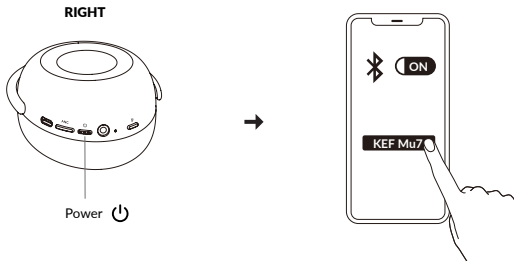

### If a device was connected before

1. Mu7 will attempt to search previous connected devices, the LED will start blinking white.
2. Once Mu7 is connected to the devices, the LED will change to solid white.
3. If no device is found, it will automatically enter Bluetooth pairing mode after 10 seconds. The LED will then change to blinking blue.
4. Voice prompt “Ready to pair” can be heard.
5. Pair the Mu7 by going to the Bluetooth setting page of your device and select “KEF Mu7” from your Bluetooth device list.
6. Once Mu7 is paired and connected, the LED will turn solid white.

### Pair Mu7 with a second device

1. Long press "Bluetooth" button and the original connected device 1 will be disconnected. Mu7 will enter Bluetooth pairing mode with the LED in blinking blue.
2. Go to the Bluetooth setting page of device 2 and select "KEF Mu7" from the device list for pairing.
3. Once Mu7 is connected to device 2, you may reconnect the Mu7 to your device 1 on its Bluetooth setting page.

OR;

Power off and on again of Mu7. Device 1 and device 2 will be connected to Mu7 automatically.

### Pair a new device to Mu7 manually

1. Long press "Bluetooth" button to activate Bluetooth pairing mode, and the LED will turn blinking blue. Voice prompt "Ready to pair" can be heard.
2. Go to the Bluetooth setting page of your device and select "KEF Mu7" from your Bluetooth device list.
3. Once Mu7 is paired and connected, the LED will turn to solid white.

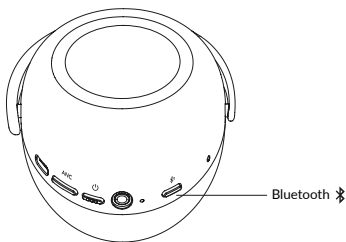

### Clear paired Bluetooth device list

1. Long press “Bluetooth + Power” buttons for more than 8 seconds.
2. LED will be in alternate blue and white.
3. Voice prompt “Device list cleared” can be heard.

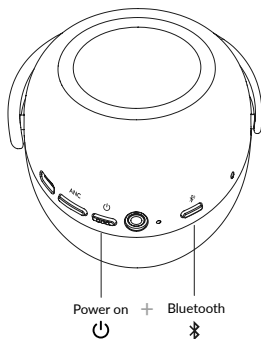

### Select ANC mode

1. By default setting, ANC mode is “ANC ON”.
2. Press “ANC” button to switch to ‘Smart ANC’ or “ANC OFF” mode.
3. If Mu7 is powered off, the current ANC mode is saved.

ANC mode sequence:

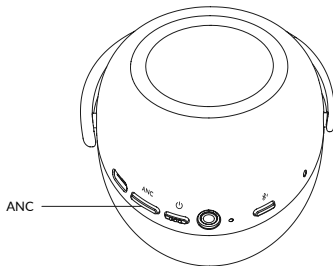
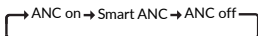



### Charge the Mu7 headphones\*

1. Use the supplied USB Type-A to Type-C cable for Mu7 charging.
2. Plug the USB-C plug into the Mu7 charging slot.
3. Plug the USB-A plug into a USB AC adaptor or computer USB port for charging.
4. The LED is blinking white during charging, and LED will be off once charging is complete.

\*Mu7 is inoperable during charging.

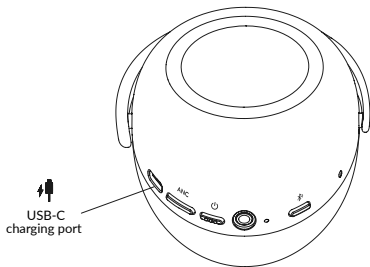

### Low battery warning

1. Low battery warning will start when you have less than 20 minutes of playback time left.
2. A warning voice prompt "Power low, please charge" can be heard and the LED will start blinking white .
3. The warning voice prompt "Power low, please charge" will repeat in 10 minutes.
4. In the last 5 minutes, the voice prompt will repeat every minute. In the last minute, it will repeat every 30 seconds. Charge your Mu7 as soon as possible.

## Disable touch sensing control

1. Long press “ANC” buttons to disable the Mu7 touch sensing control function.
2. Voice prompt “Touch disabled” can be heard.
3. All controls using touch sensing for music, call or voice control will be disabled.
4. To activate the touch sensing control again, long press the “ANC” button to resume.
5. Voice prompt “Touch enabled” can be heard.

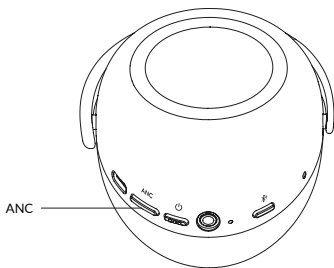

## Connection with 3.5mm audio cord

3.5mm audio connection is available if a wired connection is preferred. It can unlock the uncompressed high-resolution playback from compatible devices and dedicated headphone DAC/amplifiers.

- Use the supplied 3.5mm audio cord for Mu7 wired connection.
- 3.5mm audio cord connection can be used in Power on and Power off mode.
- With 3.5mm audio cord connection, Mu7 Bluetooth function and Touch sensing control are disabled.
- To enable ANC function, power on the Mu7 for ANC mode selection.
- Once the Mu7 is powered on with 3.5mm audio cord connection, power off function will be disabled. Mu7 will turn off automatically if you unplug the 3.5mm audio cord.

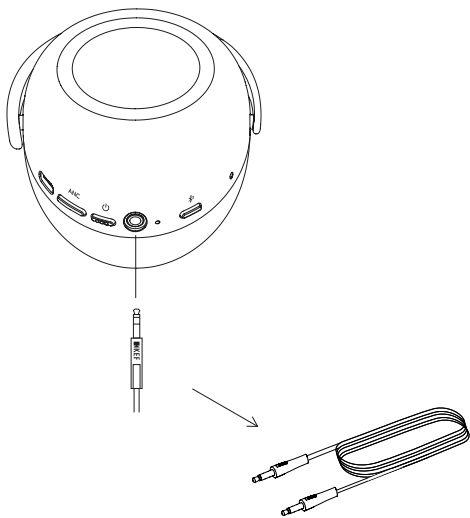

## Headphones Controls

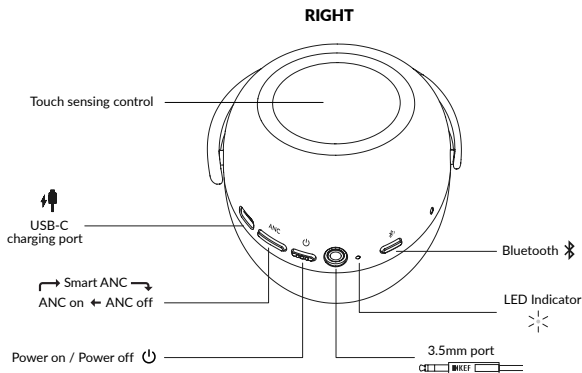

Button / Port	Function
Touch sensing control	Music, call and voice controls
USB-C charging port	Battery charge and Servicing
ANC*	ANC mode change
Power	Power on and off
3.5mm port	3.5mm audio cable connection
Bluetooth	Bluetooth pairing with other device

\*Upon first use, ANC mode default setting is 'ANC on'.

## Music and Voice Controls

**RIGHT**

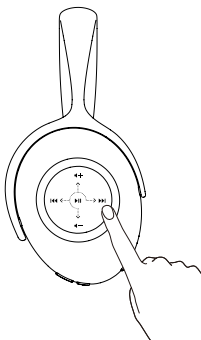

### Music Control

	Function	Touch sensing control (Right earpad)
▶	Play / Pause	Tap once
🔊+	Volume up	Swipe up ↑ / Swipe up ↑ and hold
🔊-	Volume down	Swipe down ↓ / Swipe down ↓ and hold
⏮	Previous track	Swipe backward ←
⏭	Next track	Swipe forward →

### Voice Control

	Function	Touch sensing control (Right earpad)
🗣️	Voice assistant*	Tap and hold



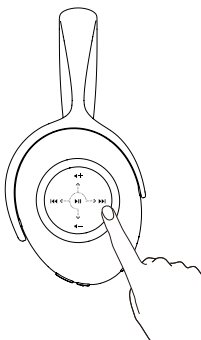

\*To activate Siri or Google Assistant on your mobile device

## Call Control

RIGHT



## Call Control

	Function	Touch sensing control (Right earpad)
	Accept / End call	Tap once
	Volume up	Swipe up ↑ / Swipe up ↑ and hold
	Volume down	Swipe down ↓ / Swipe down ↓ and hold
	Reject call	Swipe backward ← / Swipe forward →
	Mute / Unmute the mic	Tap and hold

## LED Indicator Light

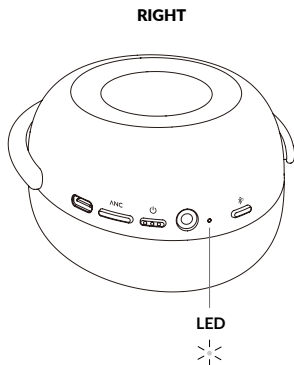

	<b>LED light colour (Right earpad)</b>	<b>Function / Indicator</b>
	Solid white	Power on
	Blinking blue	Bluetooth pairing
	Solid white	Bluetooth connected
	Blinking white	Low battery / battery charging
	LED off	Battery fully charged

## Voice Prompt

Function	Voice prompt
Power on	"Power on"
Power off	"Power off"
Bluetooth Pairing	"Ready to pair"
Bluetooth Connected	"Connected"
Bluetooth Disconnected	"Disconnected"
Bluetooth Connect to Device 1	"Device one connected"
Bluetooth Connect to Device 2	"Device two connected"
Bluetooth Disconnect with Device 1	"Device one disconnected"
Bluetooth Disconnect with Device 2	"Device two disconnected"
ANC mode on	"ANC"
Smart ANC mode	"Smart ANC"
ANC mode off	"Off"
Battery level < 20 mins	"Power low, please charge"
Call muted	"Microphone off"
Call unmuted	"Microphone on"
Disable touch sensing control	"Touch disabled"
Enable touch sensing control	"Touch enabled"
Bluetooth device memory cleared	"Device list cleared"



## Specifications

<b>Model</b>	<b>Mu7</b>
Product	Bluetooth headphones
Active noise cancellation	ANC on, Smart ANC, ANC off
Speaker drivers	40mm
Frequency range	20-20000Hz
Max power output	15mW
Bluetooth	5.1
Codec	SBC, AAC, aptX, aptX HD
Bluetooth power	Class 2
Bluetooth range	10m
Bluetooth frequency	2.402GHz - 2.48GHz
Li-ion rechargeable battery	1100mAh
Battery playtime (BT + ANC on)	Up to 40 hrs
Fast charging (15 mins)	Up to 8 hrs
Dimension (H x W x D)	199 x 153 x 89mm
Weight	309g
Operating temperature	-10°C to 45°C
Power input	DC 5V 900mA

KEF reserves the right, in line with continuing research and development, to amend or change specifications. E&OE.