

Wharfedale

INSTALLATION SPEAKER SERIES

WCM-65 | WCM-80 | WWS-65 | WWS-80 | WOS-53 | WOS-65



WCM-65 | WCM-80
In-Ceiling Speakers



WWS-65 | WWS-80
In-Wall Speakers



WOS-53 | WOS-65
All-Weather Outdoor
Speakers

Wharfedale proudly introduce 6 new highly durable, high fidelity speaker models for discreet indoor and outdoor sound reproduction.

The new line of speakers include 2 in-ceiling mounted models (WCM-65, WCM-80), 2 in-wall mounted models (WWS-65, WWS-80) and two all-weather outdoor speakers (WOS-53, WOS-65). Each speaker demonstrates Wharfedale's lifetime lasting build, with a musically thrilling sound.

The edgeless exterior design on WCM and WWS models with magnetic micro-perforated grilles guarantee a seamless blend between wall, ceiling and speaker. While externally the speakers are simplistic and discreet, advanced drivers and crossover networks are housed within. The rigid polypropylene LF cone paired with an ultra-durable, high-excursion rubber surround guarantees stability under high pressure and extensive bass output. Titanium dome tweeters with highly efficient neodymium motor systems complete each speakers' wide frequency response with a scintillating high frequency and wide dispersion (with a rotatable tweeter on WCM models for optimised positioning).

The WOS-53 and WOS-65 are all-weather outdoor speakers. With an IP67 rating, both speakers implement technology to withstand tough outdoor conditions including electroplated mylar coated polypropylene woofers for moisture rejection and rust-proof hardware including aluminium grilles and rotatable U-shaped brackets. With a high power handling and a molded, paintable PVC enclosure, these speakers are built for resilient performance with formidable sound output.



Wharfedale

IAG House, 13/14 Glebe Road, Huntingdon, Cambridgeshire, PE29 7DL, UK



WCM & WWS Key Features:

- In-Wall / In-Ceiling Speakers
- Edgeless Design for discreet installation
- Magnetically attached grilles
- Optional square grilles (WCW)
- 1-inch Titanium swivel NEO tweeter
- Gold Plated Spring Loaded Terminals
- Easy Install Safe Lock Mechanism
- PP Cone with high excursion rubber surround
- Thermal tweeter protection
- +/- 3dB bass & treble controls
- 6.5" and 8" Models



WOS Key Features:

- All-Weather Outdoor Speakers
- All rust proof Aluminium screws, brackets & grilles
- Extremely versatile molded PVC enclosure with UV protection
- 3/4" hard dome tweeters
- Two mounting options: bookshelf or bracket
- Directional positioning for better sound dispersion
- Electroplated mylar woofer cones with UV protection
- Paintable to match any decor, indoor or outdoor
- High power handling
- Gold plated binding posts
- IP67 - Excellent for all applications including marine
- 5.25" and 6.5" models



WCM-65

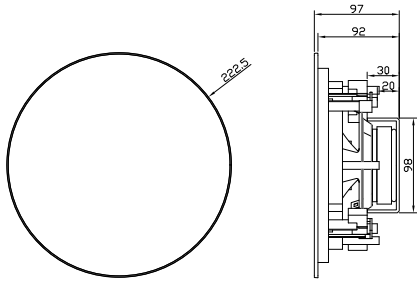

WCM-80

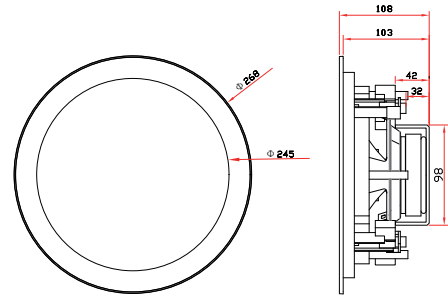

WWS-65

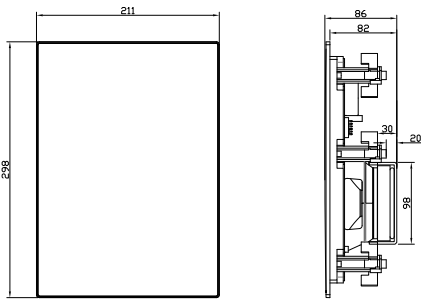

WWS-80

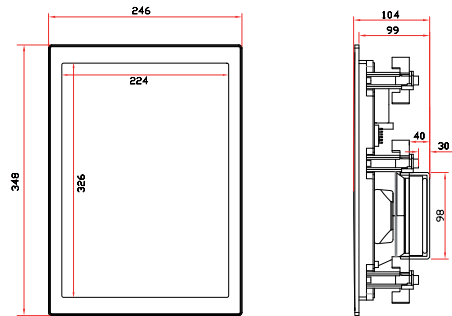

WOS-53

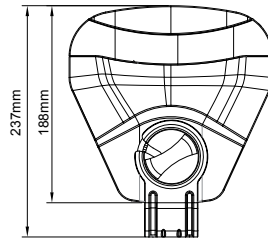
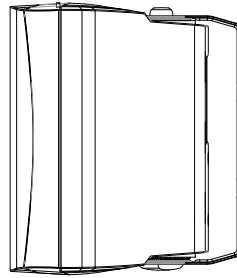
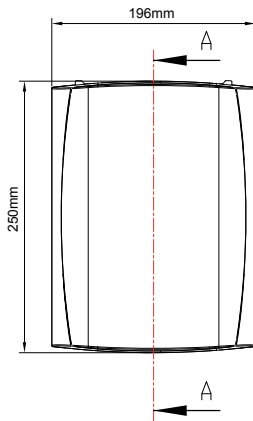

WOS-65

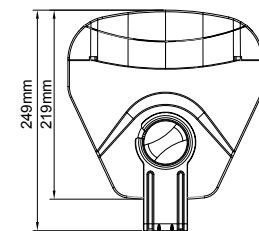
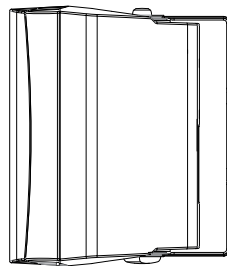
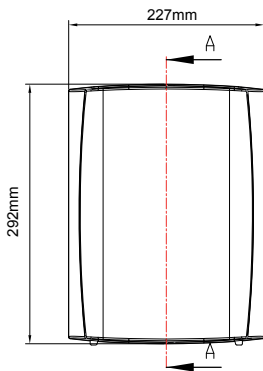

Specifications

	WCM-65	WCM-80	WWS-65	WWS-80	WOS-53	WOS-65
General description	In-Ceiling Mounted	In-Ceiling Mounted	In-Wall Speaker	In-Wall Speaker	All Weather Outdoor Speaker	All Weather Outdoor Speaker
Transducer complement	2-Way	2-Way	2-Way	2-Way	2-Way	2-Way
Bass driver	6.5" / 165mm Polypropylene	8" / 200mm Polypropylene	6.5" / 165mm Polypropylene	8" / 200mm Polypropylene	5.25" / 135mm Polypropylene	6.5" / 165mm Polypropylene
Treble driver	1" Titanium Dome	1" Titanium Dome	1" Titanium Dome	1" Titanium Dome	1" Hard Dome, Ferro-fluid cooled	1" Hard Dome, Ferro-fluid cooled
HF Adjust	+/- 3dB	+/- 3dB	+/- 3dB	+/- 3dB	n/a	n/a
LF Adjust	+/- 3dB	+/- 3dB	+/- 3dB	+/- 3dB	n/a	n/a
Terminals	Gold Plated, Spring Loaded	Gold Plated, Spring Loaded	Gold Plated, Spring Loaded	Gold Plated, Spring Loaded	Gold Plated	Gold Plated
Grille & hardware	Magnetic Micro-perf Grille	Magnetic Micro-perf Grille	Magnetic Micro-perf Grille	Magnetic Micro-perf Grille	Rust-free Aluminum Grille Rotatable Steel U-Shaped Bracket	Rust-free Aluminum Grille Rotatable Steel U-Shaped Bracket
Protection	Auto Protect Reset Switch / Over Power Protection	Auto Protect Reset Switch / Over Power Protection	Auto Protect Reset Switch / Over Power Protection	Auto Protect Reset Switch / Over Power Protection	Auto Protect Reset Switch / Over Power Protection	Auto Protect Reset Switch / Over Power Protection
IP Rating	n/a	n/a	n/a	n/a	IP67	IP67
Sensitivity (2.83V @ 1m)	87dB	88dB	88dB	89dB	88dB	89dB
Power (RMS / Peak)	30W / 80W	40W / 100W	30W / 80W	40W / 100W	30W / 80W	40W / 100W
Recommended amplifier power	20W - 120W	30W - 140W	20W - 120W	30W - 140W	20W - 120W	30W - 140W
Peak SPL	97dB	98dB	98dB	99dB	98dB	99dB
Nominal impedance	8 Ohms	8 Ohms	8 Ohms	8 Ohms	8 Ohms	8 Ohms
Frequency response (+/-3dB)	65Hz - 20kHz	45Hz - 20kHz	63Hz - 20kHz	43Hz - 20kHz	70Hz - 20kHz	65Hz - 20kHz
Crossover	12dB Per Octave	12dB Per Octave	12dB Per Octave	12dB Per Octave	12dB Per Octave	12dB Per Octave
Cut-Out Dimensions	201mm Inner Diameter	245mm Inner Diameter	191mm x 278mm	326 x 224 mm	n/a	n/a
Mounting Depth	100mm	103mm	99mm	99mm	n/a	n/a
Dimensions	225mm (Diameter) x 97mm	268mm (Diameter) x 108mm	298mm x 211mm x 86mm	348mm x 246mm x 104mm	250mm x 196mm x 237mm	292mm x 227mm x 249mm
Net weight	1.23kg	1.8kg	1.5kg	2.0kg	3.66kg	5.3kg
Finish	Black polypropylene body with white sprayable grille	Black polypropylene body with white sprayable grille	Black polypropylene body with white sprayable grille	Black polypropylene body with white sprayable grille	White polypropylene with aluminum grille & hardware	White polypropylene with aluminum grille & hardware

