

 PERLISTEN

perceptual listening experience

 series

THX Certified Dominus Subwoofers



Welcome to the World's first THX Certified Dominus Subwoofer

Congratulations, on your purchase of the world's first THX Certified Dominus family of subwoofers. We designed these products to ensure maximum output with the lowest distortion to recreate the dynamics that are needed for realistic 2-channel and cinema experiences. This new experience level is created using innovative engineering and many advanced technologies.

We recommend that you take some time to read this manual before starting the installation and setup. For more information about Perlisten subwoofers and other products, please visit our website at

<https://www.perlistenaudio.com/>

For support please contact Support@perlistenaudio.com

Note: This guide is applicable to all Perlisten THX Certified Dominus D-series subwoofers. D12s, D15s, D212s, D215s. Use the bar code below to download the Perlisten App from the Google Playstore.



Product Description

Subwoofer driver

Our subwoofer drivers are designed by the Perlisten engineering team from the ground up using a carbon fiber composite diaphragm, an aluminum alloy shorting ring, huge magnets for efficiency, a durable multilayer Nomex spider and a lightweight aluminum alloy voice coil. The Perlisten engineering team uses advanced FEA modeling technology to simulate and design these raw components and Klippel laser measurement testing is then used to validate the results to ensure every ounce of performance is achieved. Our flagship D212s and D215s also incorporate our Push-Pull woofer alignment to reduce even order harmonics by an additional 10-12dB.

Amplifier

Our amplifiers have a rated power of 1500W (D12s), 2000W (D15s), and 3000W (D212s, D215s). Temperature, current, voltage and much more, are dynamically monitored at more than 1000 times a second with our 48 bit data path 32-bit ARM Cortex processor which reacts in microseconds to ensure maximum performance. All of this power is managed by our 2.4" touchscreen and with more advanced features controlled by our APP.

Mobile APP

Our app can be downloaded from the Android Play Store or the app store for iOS by scanning the bar codes on the previous page to enable maximum control of our subwoofers. The APP details will be discussed later in this manual and can be downloaded on our website "Downloads" page or scan the QR code below. Just a few of our APP features are listed below.

- Perlisten subwoofers can be connected to iOS and Android mobile devices for settings and control of up to 8 subwoofers simultaneously which is both powerful and flexible.
- Perlisten subwoofer parameter status information and the APP communicate in real-time to have dynamic real-time control of your subwoofer settings.
- Preset equalizer modes, low-pass frequency, phase, polarity, and delay
- Three independent PEQ presets, and each preset is comprised of 10 separate parametric EQ's. Settings can be copied to other Perlisten subwoofers.
- Many more user-friendly control options for maximum flexibility.



D12s



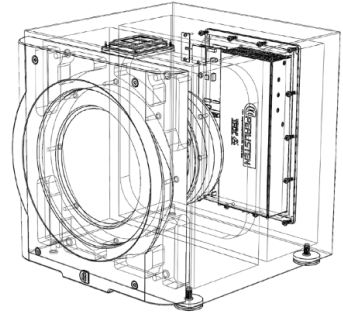

MODEL D12s Subwoofer: Small footprint, big sound. Benefiting from many of the technologies of our flagship subs, these sealed subs generate amazing performance in the smallest footprint. Low Q, shallow rolloff response geared for sound quality and smoothly integrating into the listening room. Also, a great choice for using multiple subs to optimize in room response and smooth out seat-to-seat variation. The smallest subwoofer in the series, yet packs enough punch to be certified THX Dominus using a pair of D12s subs. Powered by our 15kW amplifier, all functions and safeties are controlled by a 48-bit data path DSP and 32-bit ARM M4 Cortex processor, able to react in microseconds, powerful enough to slam. Ground up drivers developed by our team of engineers. Carbon fiber composite diaphragms, multiple aluminum shorting rings, massive magnets, multi-layer Nomex spiders and lightweight aluminum voice coil wire are the key ingredients - Proprietary nonlinear modeling techniques allow us to simulate all these components and then optimize for real world driver performance - free air and in box. Further refinement is done with the aid of Klippel laser measurements to dial things in. All D-Series subs share our 2.4" LCD touchscreen display and ability to control advance settings using our App.

D12s

Technical Specifications:	
Alignment	acoustic suspension
Amplifier	15kW rms short term
Display Interface	2.4" LCD color touchscreen
App	iOS and Android
Processor	32-bit Arm Cortex M4, double precision floating point math
DSP Engine	Ti DSP 48-bit data paths
Driver compliment	300mm, Carbon fiber diaphragm +/-30mm linear excursion
Reference sensitivity	92dB / 150mV/ 1.0m
Frequency Response	THX EQ 20-289Hz (-6dB) / 16-330Hz (-10dB) Boost (Large Room) EQ 16-289Hz (-6dB) / 14-330Hz (-10dB) Cut (Small Room) EQ 25-289Hz (-6dB) / 19-330Hz (-10dB)
Inputs	(2) Balanced XLR (2) Unbalanced RCA
Outputs	(2) Balanced XLR unbuffered (2) Unbalanced RCA unbuffered
Parametric EQ	10-Band PEQ with 3 user presets
Low Pass filter	bypass, 30-160Hz, slope 6,12,18,24dB/oct
Phase	variable 0-270°
Polarity	normal / inverted
Configurable Auto turn-on and 12v Trigger	XLR 1, XLR 1+2, RCA 1, RCA 1+2
Dimensions (HxWxD)	448 x 420 x 450mm 17.6 x 16.5 x 17.7"
Weight	41.0 kg (90.2 lbs.)
Certification	THX Dominus
Available finishes	piano black, custom finishes available

APP Control - iOS and Android



Advanced APP User interface - customizable turn-on controls and input selection, multiple PEQ's with presets.

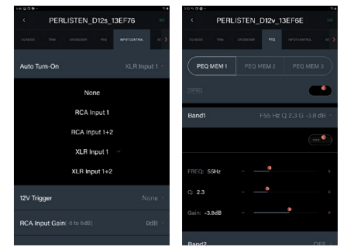

Processor - 32-bit ARM Cortex M4



DSP Engine - 48-bit data paths



D15s



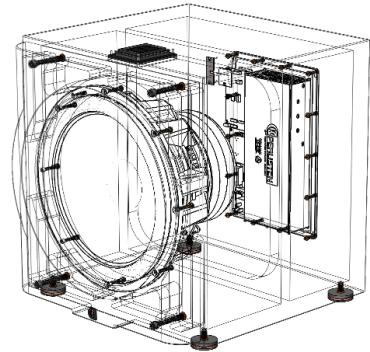
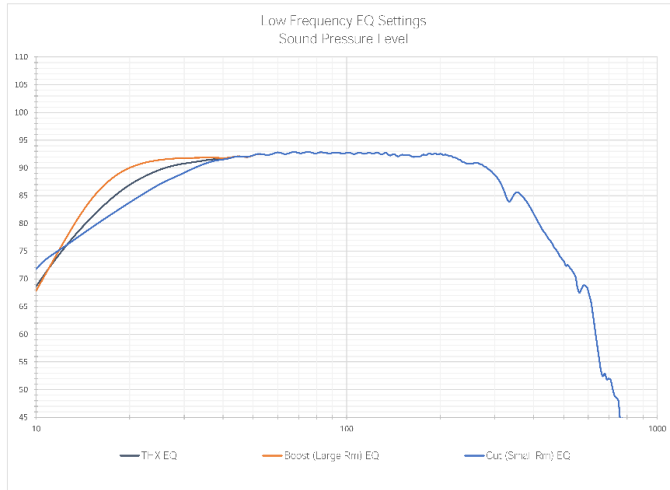

MODEL D15s Subwoofer: Small footprint, big sound. Benefiting from many of the technologies of our flagship subs, these sealed subs generate amazing performance in the smallest footprint. Low Q, shallow rolloff response geared for sound quality and smoothly integrating into the listening room. Also, a great choice for using multiple subs to optimize in room response and smooth out seat-to-seat variation. The D15s is the smallest single sub certified THX Dominus available on earth. Powered by our 2.0kW amplifier, all functions and safeties are controlled by a 48-bit data bath DSP and 32-bit ARM M4 Cortex processor, able to react in microseconds, powerful enough to slam. Ground up drivers developed by our team of engineers. Carbon fiber composite diaphragms, multiple aluminum shorting rings, massive magnets, multi-layer Nomex spiders and lightweight aluminum voice coil wire are the key ingredients - Proprietary nonlinear modeling techniques allow us to simulate all these components and then optimize for real world driver performance - free air and in box. Further refinement is done with the aid of Klippel laser measurements to dial things in. All D-Series subs share our 2.4" LCD touchscreen display and ability to control advance settings using our App.

APP Control - iOS and Android



Advanced APP User interface - customizable turn-on controls and input selection, multiple PEQ's with presets.

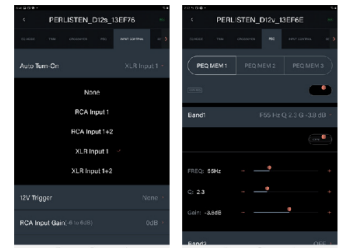

Processor - 32-bit ARM Cortex M4



DSP Engine - 48-bit data paths



D15s

Technical Specifications:

Alignment	acoustic suspension
Amplifier	2.0kW rms short term
Display Interface	2.4" LCD color touchscreen
App	iOS and Android
Processor	32-bit ARM Cortex M4, double precision floating point math
DSP Engine	Ti DSP 48-bit data paths
Driver compliment	380mm, Carbon fiber diaphragm +/-30mm linear excursion
Reference sensitivity	92dB / 150mV / 1.0m
Frequency Response	
THX EQ	20-320Hz (-6dB) / 16-395Hz (-10dB)
Boost (Large Room) EQ	16-320Hz (-6dB) / 14-395Hz (-10dB)
Cut (Small Room) EQ	24-320Hz (-6dB) / 18-395Hz (-10dB)
Inputs	(2) Balanced XLR (2) Unbalanced RCA
Outputs	(2) Balanced XLR unbuffered (2) Unbalanced RCA unbuffered
Parametric EQ	10-Band PEQ with 3 user presets
Low Pass filter	bypass, 30-160Hz, slope 6,12,18,24dB/oct
Phase	variable 0-270°
Polarity	normal / inverted
Configurable Auto turn-on and 12v Trigger	XLR 1, XLR 1+2, RCA 1, RCA 1+2
Dimensions (HxWxD)	528 x 500 x 500mm 20.8 x 19.7 x 19.7"
Weight	46.0 kg (101.2 lbs.)
Certification	THX Dominus
Available finishes	piano black custom finishes available



D 212s



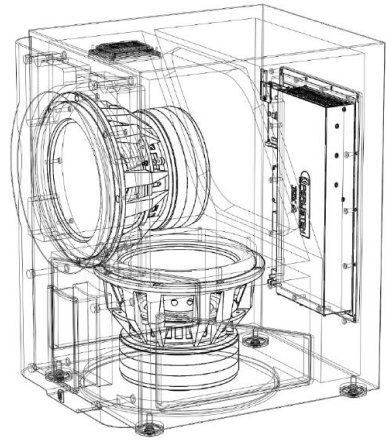
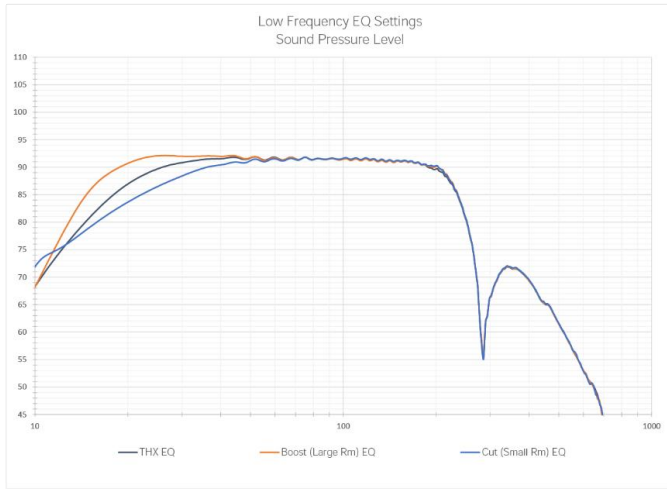

MODEL D212s Subwoofer: Dynamic, Accurate, Solid. The audiophile's choice. Where sound quality and Transients free of overhang are paramount. Simply no better expression of bass performance then our push-pull subs. Ground up drivers developed by our team of engineers. Carbon fiber composite diaphragms, multiple aluminum shorting rings, massive magnets, multi-layer Nomex spiders and lightweight aluminum voice coil wire are the key ingredients - Proprietary nonlinear modeling techniques allow us to simulate all these components and then optimize for real world driver performance - free air and in box. Further refinement is done with the aid of Klippel laser measurements to dial things in. To take performance to another level, the push-pull drivers reduce even order harmonics distortion by an additional 10-12dB. Powered by our 3.0kW amplifier, all functions and safeties are controlled by a 48-bit data bath DSP and 32-bit ARM M4 Cortex processor, able to react in microseconds, powerful enough to slam. All D-Series subs share our 2.4" LCD touchscreen display and ability to control advance settings using our App. Certified by THX Dominus, The D-Series subs are the world's first. A testament to the level of design and performance achieved.

D212s

Technical Specifications:

Alignment	Push-Pull, acoustic suspension
Amplifier	3.0kW rms short term
Display Interface	2.4" LCD color touchscreen
App	iOS and Android
Processor	32-bit Arm Cortex M4, double precision floating point math
DSP Engine	Ti DSP 48-bit data paths
Driver compliment	(2)300mm, Carbon fiber diaphragm +/-30mm linear excursion
Reference sensitivity	92dB / 150mV/ 1.0m
Frequency Response	
THX EQ	20-231Hz (-6dB) / 16-245Hz (-10dB)
Boost (Large Room) EQ	15-231Hz (-6dB) / 13.5-245Hz (-10dB)
Cut (Small Room) EQ	24-231Hz (-6dB) / 18-245Hz (-10dB)
Inputs	(2) Balanced XLR (2) Unbalanced RCA
Outputs	(2) Balanced XLR unbuffered (2) Unbalanced RCA unbuffered
Parametric EQ	10-Band PEQ with 3 user presets
Low Pass filter	bypass, 30-160Hz, slope 6,12,18,24dB/oct
Phase	variable 0-270°
Polarity	normal / inverted
Configurable Auto turn-on and 12v Trigger	XLR 1, XLR 1+2, RCA 1, RCA 1+2
Dimensions (HxWxD)	668 x 420 x 550mm 26.3 x 16.5 x 21.6"
Weight	68.0 kg (149.6 lbs.)
Certification	THX Dominus
Available finishes	piano black custom finishes available

APP Control - iOS and Android



Advanced APP User interface - customizable turn-on controls and input selection, multiple PEQ's with presets.

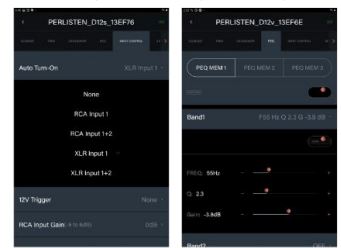

Push-Pull - Asymmetrical Distortion killer



D 215s



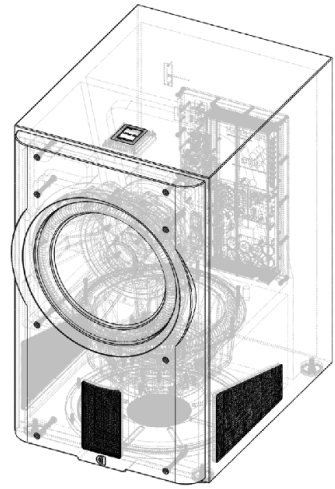
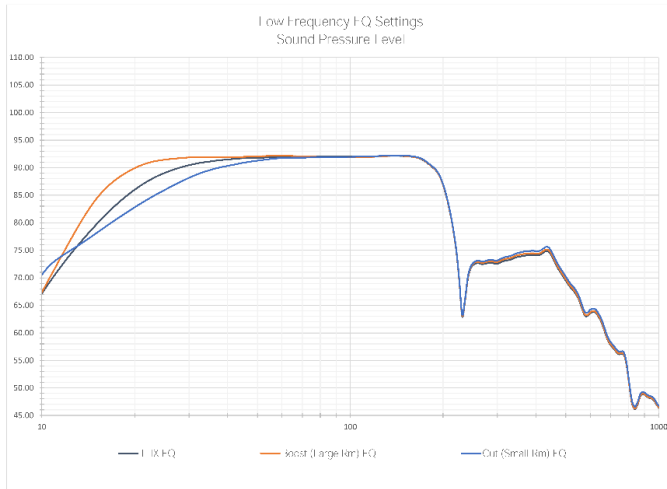

MODEL D215s Subwoofer: Dynamic, Accurate, Solid. The audiophile's choice. Where sound quality and Transients free of overhang are paramount. Simply no better expression of bass performance than our push-pull subs. Ground up drivers developed by our team of engineers. Carbon fiber composite diaphragms, multiple aluminum shorting rings, massive magnets, multi-layer Nomex spiders and lightweight aluminum voice coil wire are the key ingredients - Proprietary nonlinear modeling techniques allow us to simulate all these components and then optimize for real world driver performance - free air and in box. Further refinement is done with the aid of Klippel laser measurements to dial things in. To take performance to another level, the push-pull drivers reduce even order harmonics distortion by an additional 10-12dB. Powered by our 3.0kW amplifier, all functions and safeties are controlled by a 48-bit data path DSP and 32-bit ARM M4 Cortex processor, able to react in microseconds, powerful enough to slam. All D-Series subs share our 2.4" LCD touchscreen display and ability to control advance settings using our App. Certified by THX Dominus, The D-Series subs are the world's first. A testament to the level of design and performance achieved.

D215s

Technical Specifications:	
Alignment	Push-Pull, acoustic suspension
Amplifier	3.0kW rms short term
Display Interface	2.4" LCD color touchscreen
App	iOS and Android
Processor	32-bit ARM Cortex M4, double precision floating point math
DSP Engine	Ti DSP 48-bit data paths
Driver compliment	(2)380mm, Carbon fiber diaphragm +/-30mm linear excursion
Reference sensitivity	92dB / 150mV/ 1.0m
Frequency Response	THX EQ 20-200Hz (-6dB) / 16-210Hz (-10dB) Boost (Large Room) EQ 15-200Hz (-6dB) / 13-210Hz (-10dB) Cut (Small Room) EQ 24-200Hz (-6dB) / 18-210Hz (-10dB)
Inputs	(2) Balanced XLR (2) Unbalanced RCA
Outputs	(2) Balanced XLR unbuffered (2) Unbalanced RCA unbuffered
Parametric EQ	10-Band PEQ with 3 user presets
Low Pass filter	bypass, 30-160Hz, slope 6,12,18,24dB/oct
Phase	variable 0-270°
Polarity	normal / inverted
Configurable Auto turn-on and 12v Trigger	XLR 1, XLR 1+2, RCA 1, RCA 1+2
Dimensions (HxWxD)	805 x 500 x 650.5mm 31.7 x 19.7 x 25.6"
Weight	92.0 kg (202.4 lbs.)
Certification	THX Dominus
Available finishes	piano black custom finishes available

APP Control - iOS and Android



Advanced APP User interface - customizable turn-on controls and input selection, multiple PEQ's with presets.

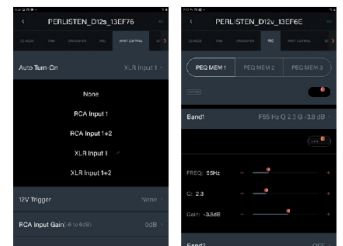

Push-Pull - Asymmetrical Distortion killer



THX Speaker Certifications-Choosing a THX Certified Dominus system

Model	Dominus	Ultra
S7t	LCR Large	
S7c	LCR Large	
S5m	Surround	LCR
S4b	Surround/Height	
S4s	Surround/Height	
R5t	Surround	LCR
D12s	Two Subs	One sub
D15s	One sub	
D212s	One Sub	
D215s	One sub	

Use the chart above as a guide to choosing the right components to reach the certification required or desired. Perlisten Speakers have been certified to meet the requirements for THX Certified Dominus and thus also meet the requirements for all other THX certification levels as per the chart.

THX Certified Dominus ensures these speakers have the output capability for reaching the reference listening level in a room at 6500 cubic feet or 184 cubic meters with a minimum of a 7.1.4 loudspeaker arrangement that is required to meet Dominus level. Keep in mind that the LFE is considered one single channel as a whole no matter the quantity of the subs in the system. Though all most all of our subwoofers meet or exceed the output and low distortion criteria with a single subwoofer it is recommended to have 4 subwoofers in a system to provide the most balanced frequency response for all seating positions.

Subwoofer packaging

Subwoofer box contents

Warning, your new Perlisten subwoofer is very heavy and set up is best done with two people.

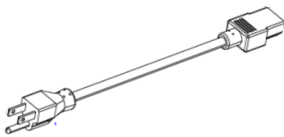
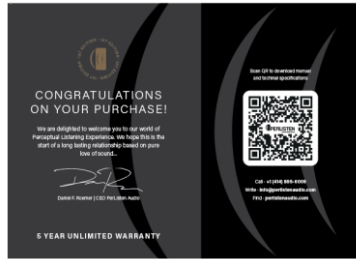
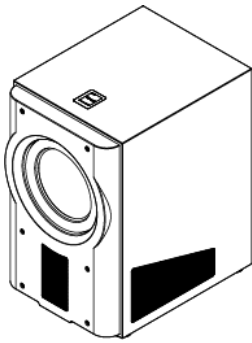

Carpet pad x4

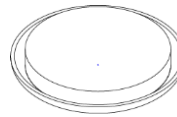

Hard surface pad x4

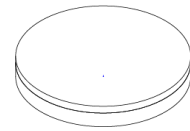

Prepping the area

The subwoofer artwork on the packaging indicates the front of the actual subwoofer inside the box. Use this guide to position the subwoofer as close as possible to its final position. Included in the box are 4 carpet pads with a hard plastic bottom for smooth sliding into final position on carpet or soft felt pads for a hard floor to prevent scratching delicate flooring.

For the D212s and the D215s cut the plastic straps holding the subwoofer packaging together. Do not cut the tape and open the flaps like a typical box. Instead slide the top box vertically off the bottom. After removal of the top box open the cloth bag just enough to expose the bottom feet of the subwoofer. Then remove the extra packaging except for 1 EPE foam pad on one side of the subwoofer and use this as protection as you roll the subwoofer onto its side and continue to roll the enclosure onto its feet. This prevents damage from occurring during the critical placement operation. Use the carpet pads or hardwood pads mentioned above to slide the woofer into final position.

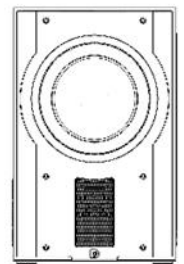
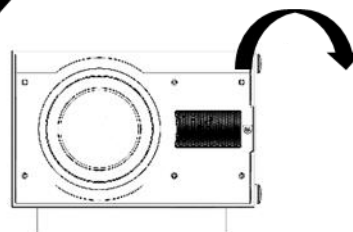
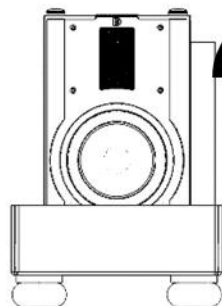
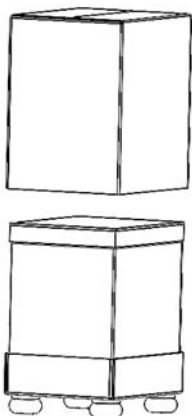

For the smaller D12s and the D15s cut the tape and open the top flaps. Open the second internal box, flip open the flaps, and remove the EPE foam. You will then see the velvet bag covering the bottom feet of the subwoofer. Remove the bag so the subwoofer feet are exposed. While holding the flaps tightly to the side of the box carefully roll the subwoofer over until the subwoofer feet are on the floor. You can then lift the box up and remove all of the packaging. Use the carpet pads or hardwood pads in the packaging to slide the woofer into final position.

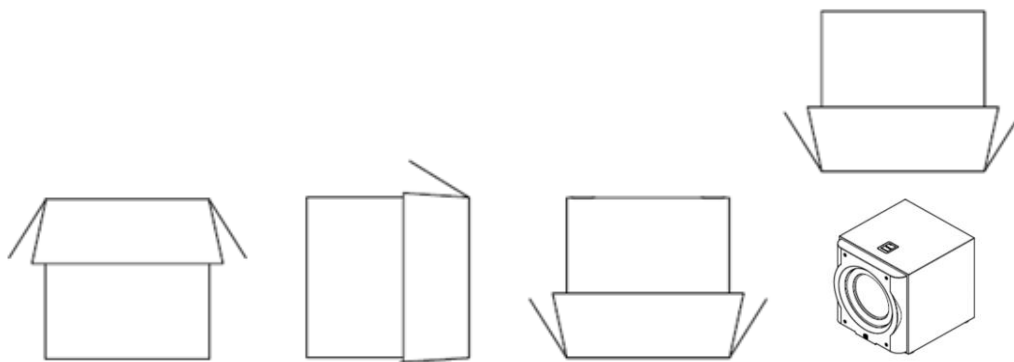

Subwoofer Placement

Subwoofer placement is critical for the best performance in your listening room.

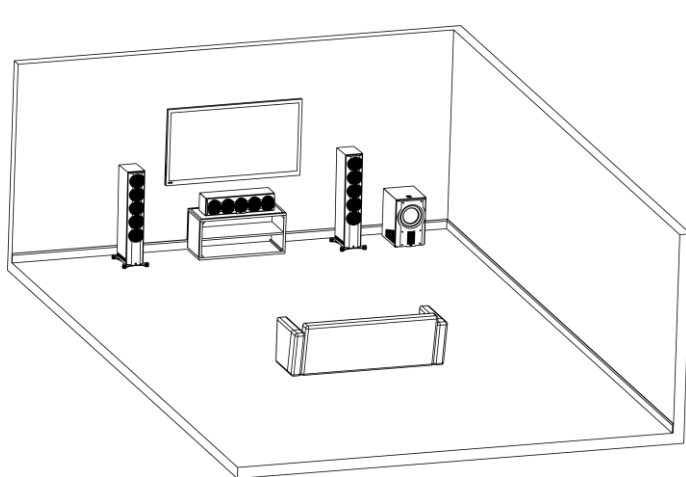

Fig. 1

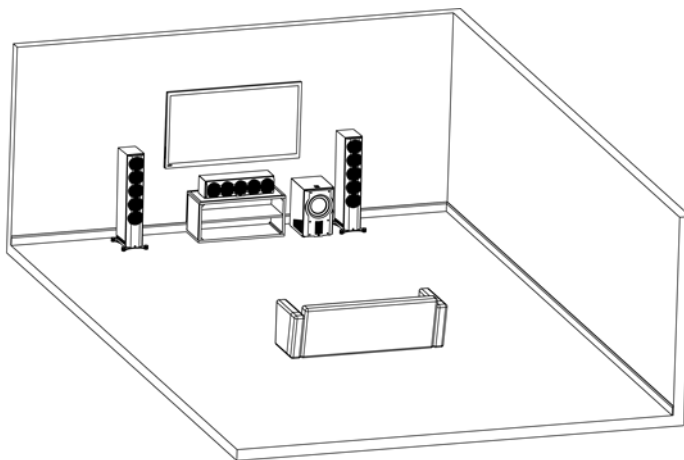
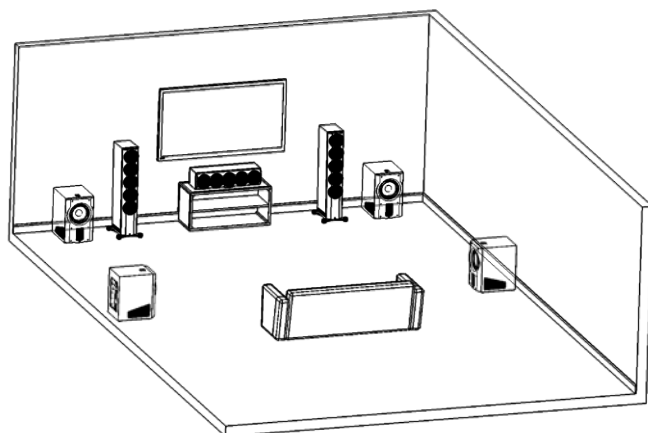
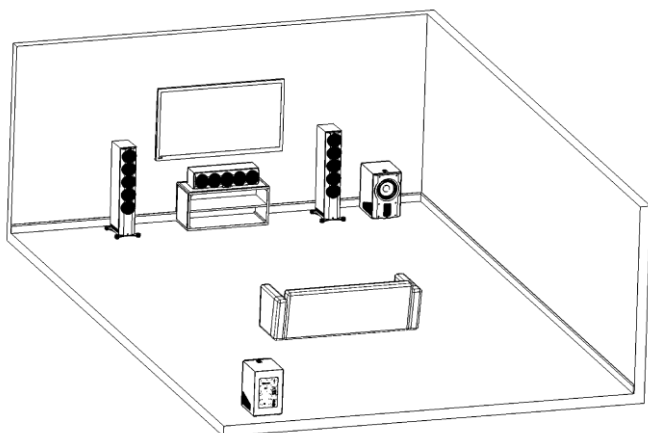
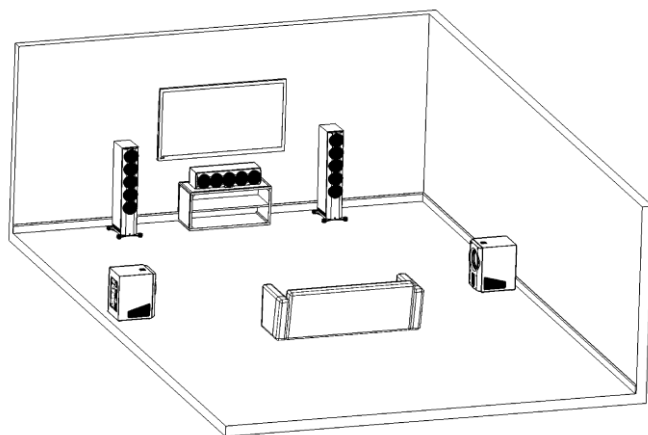
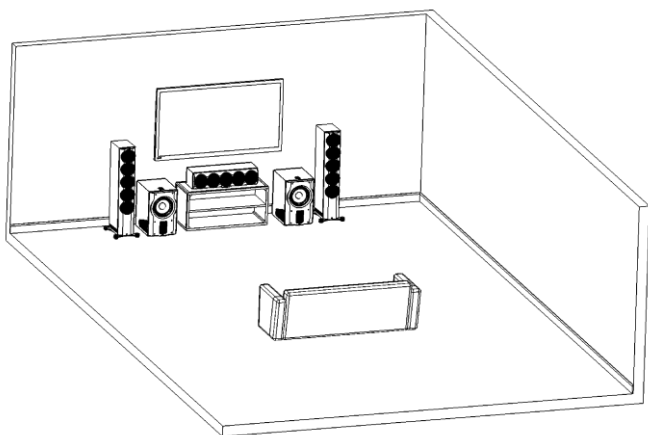

Fig. 2

For a single subwoofer like figure 1 the most output can be achieved by placing the subwoofer near a corner. This will excite the room modes the most but will also have the most un-even response from seat to seat in your listening room. Figure 2 moves the subwoofer to 1/3 the distance of the total wall length to balance the room modes that are excited in the room. The maximum SPL will be lower but a smoother response for each listening position can be achieved using this method. Enjoy experimenting with the best position in your room as there are many factors that will change the results from a typical square room compared to odd shaped rooms, open doors, and openings to other rooms.

In more advanced systems, 2-8 subs can be used to smooth out the response in the room for more listeners, as well as achieving a higher maximum output for very large spaces. Typically, 2-4 subs in different locations in a room can maximize a balanced frequency response coverage from seat to seat. Some examples of placement of 2-4 subs are shown below. More subs can be used when a very large space is needed to reach the target reference listening level and up to 8 subs can be controlled with the Perlisten subwoofer app discussed later in this manual.

Further improvements to your system can be enabled with powerful free measurement software like REW(Room Eq Wizard) to measure and equalize your room allowing multiple subs to get the flattest response possible for all listeners. Additional benefits can be achieved by maximizing your subwoofer and high frequency speakers as a complete system with advanced DSP processing capabilities from Companies like Trinnov, Storm, Dirac and others.



Power

Wall voltage and current is often overlooked but extremely important to maximize the extreme 1.5kW to 3kW power output of our subwoofers. Ignoring the wall power requirements, would be like buying a Ferrari and using putting bicycle tires on it, destroying the performance you deserve.

Our amplifiers enable advanced technologies to monitor the voltage and current available from the wall and are used to adjust our internal settings to prevent distortion when low power occurs from the wall. Our amplifiers have large capacitor banks to store power needed for large transients delivered in microseconds. This storage of energy also limits the instantaneous power demand from the wall. Although this amazing technology is designed to enable the best sound quality in all conditions such as low voltage or current, it is best to maximize the output capabilities of the subwoofer, and make sure you have proper power for the subwoofer.

Consult a certified electrician if needed to run a separate power circuit for your subwoofer. For existing electrical connections keep in mind that other electrical devices could be on the same circuit which will consume power and all devices need to be considered. Our Fuse values are below and will demand close to the stated current from the wall to maximize the dynamic transients of movies and music.

<i>D12s</i>	<i>230V</i>	<i>6.3A 250v slo-blow fuse</i>
<i>D12s</i>	<i>120V</i>	<i>10A 250v slo-blow fuse</i>
<i>D15s/D212s/D215s</i>	<i>230v</i>	<i>12.5A 250v slo-blow fuse</i>
<i>D15s/D212s/D215s</i>	<i>120v</i>	<i>20A 250v slo-blow fuse</i>

LISTEN

tual listening experience

Connections



Service

3-12V Trigger



Input



Output



Input



Output

Made in China

Amplifier panel features

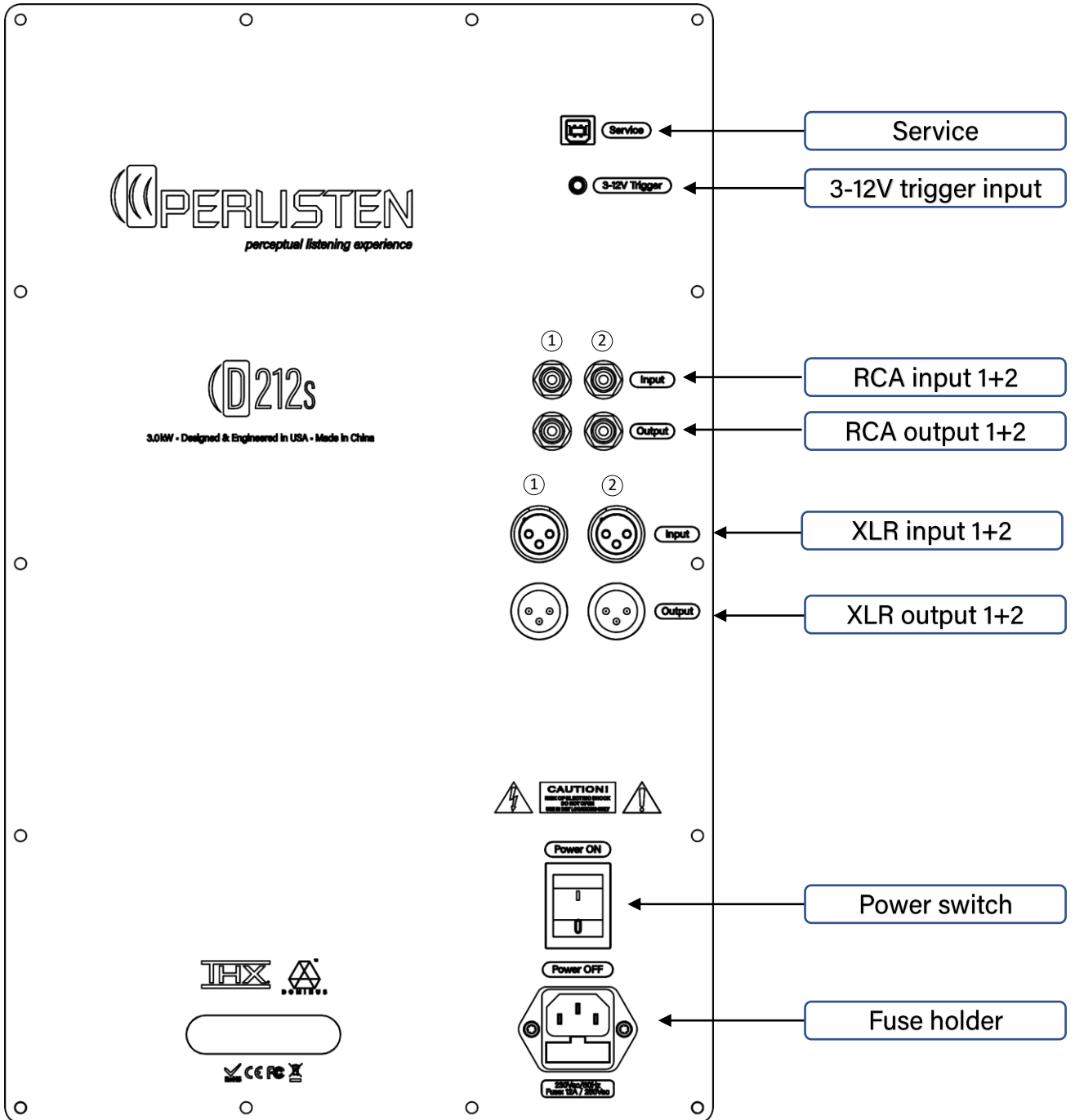

Connections

The following examples shown apply to the RCA or Balanced XLR inputs. Inputs RCA 1, or 1+2 can be used and are a direct pass through to the RCA outputs. Inputs XLR 1, or 1+2 can be used and are a direct pass through to the XLR outputs and are not buffered. The RCA inputs can accept 8Vrms and the XLR can accept up to 16Vrms input without distortion. See our App "input gain setting" in this manual for more details.

Connect the LFE out of your cinema processor to RCA 1 input or male XLR 1 input for a single subwoofer application.

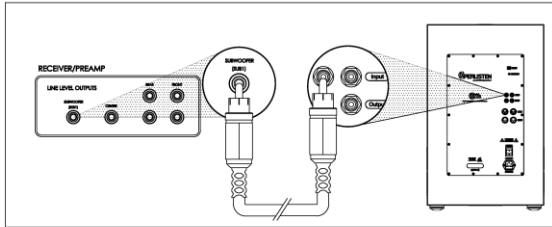

OR

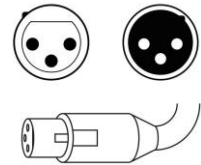

For more than one subwoofer many options are available. Most processors have more than one subwoofer output. Use those outputs for each subwoofer if available. If multiple outputs are not available use the RCA or XLR outputs to connect to the inputs of other subwoofer amp panels.

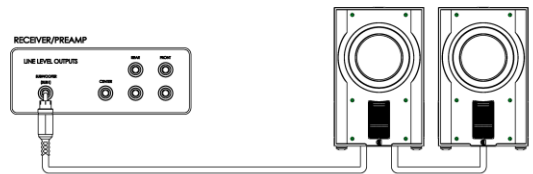
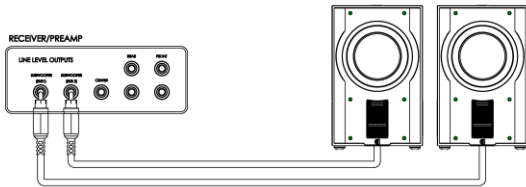

Both the RCA and XLR inputs can be connected from two different sound sources when the system is used for two channel listening and for cinema as an example. If signals are present on both inputs at the same time noise could occur due to ground loops and the trigger input will override the signal sensing to prevent a dual source input conflict. The App will also block out signal sensing input options that are not valid to prevent setup conflicts.

Signal sensing with different sensitivities of low, medium and high can be set in the App for the RCA inputs as well as 3-12v trigger, using 1/8" (3.5mm) mono plug, for the XLR's.

Default settings

The subwoofer will default to no crossover, delay, phase, or polarity adjustments to allow for full control from your LFE processor. This ensures your signal processor has no unexpected settings from the subwoofer itself. More about these adjustments in the app section.

Subwoofer Touchscreen Menu

The touchscreen located on the top of the subwoofer allows you to do immediate setup and control of your subwoofer while the App offers an immense amount of speed and flexibility for advanced set up. Utilize the App to enable these advanced features. The OSD "On Screen Display" menu is shown below. The OSD allows you to setup Master level, individual subwoofer trim, EQ modes, and input selections. The Status and test tone modes are helpful for diagnostics.

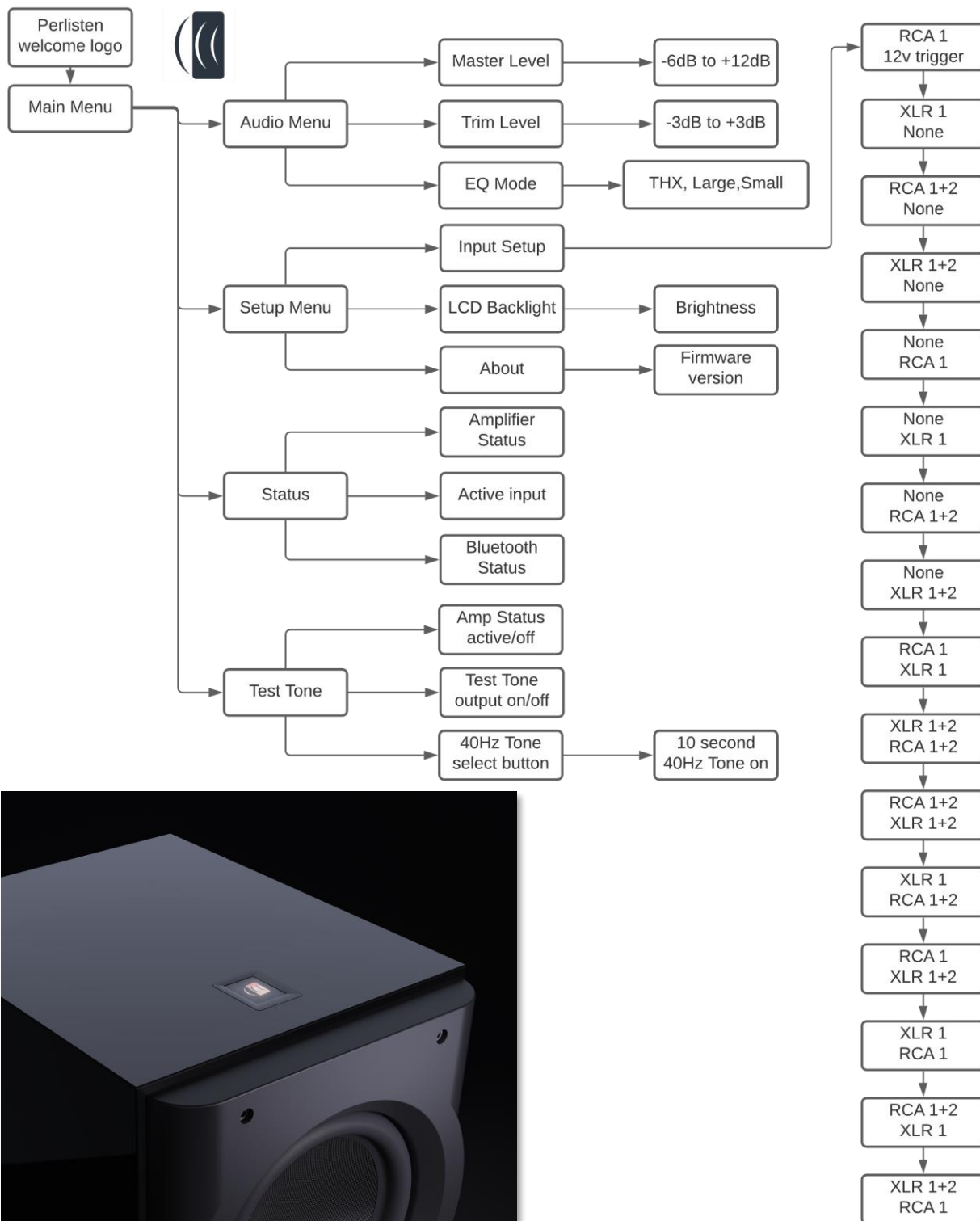

APP

Download the “Perlisten Subwoofer App” from the Google Play Store for Android devices or the App store for iOS devices. The bar codes on page 2 of this manual can also be scanned with a bar code scanning app on any phone as a second option to get the App. When scanned a direct link to the Perlisten subwoofer app will pop up. Install the App and you are ready to have maximum control of your subwoofer.

If you do not have a bar code scanning app on your phone go to the Perlisten downloads page and click on the bar code to get a direct link to the app store URL.

<https://www.perlistenaudio.com/downloads>

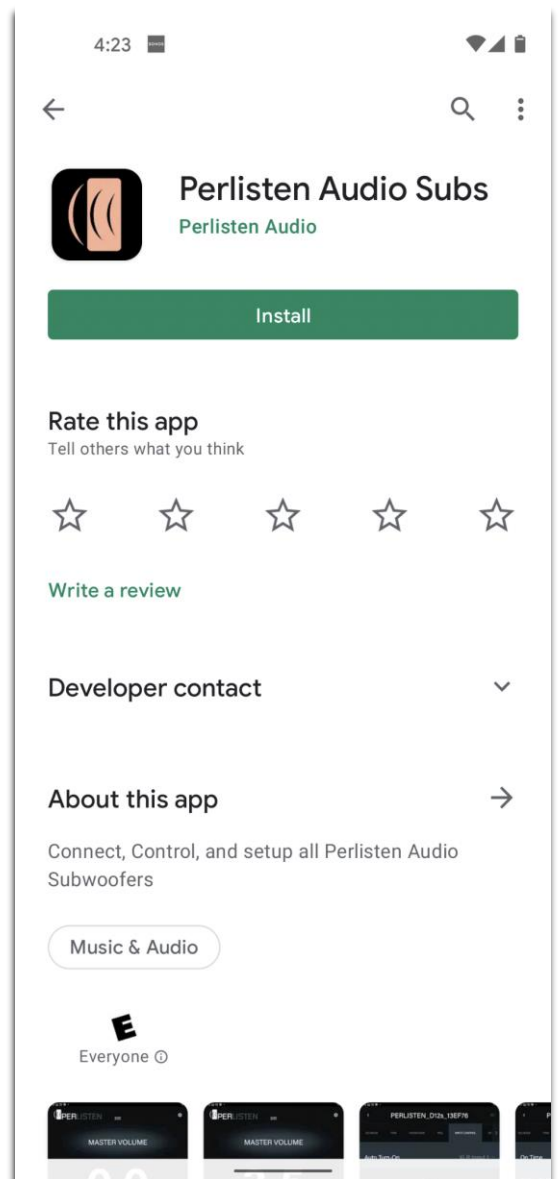

After downloading the App, and the App opens, it will immediately search for any available Perlisten subwoofers as seen below with the spinning search icon.

Note!

If another device is already connected to the subwoofers using our app, you will not be able to connect and control the subs. Disconnect the other phone or tablet to connect to the subwoofer with the intended device.

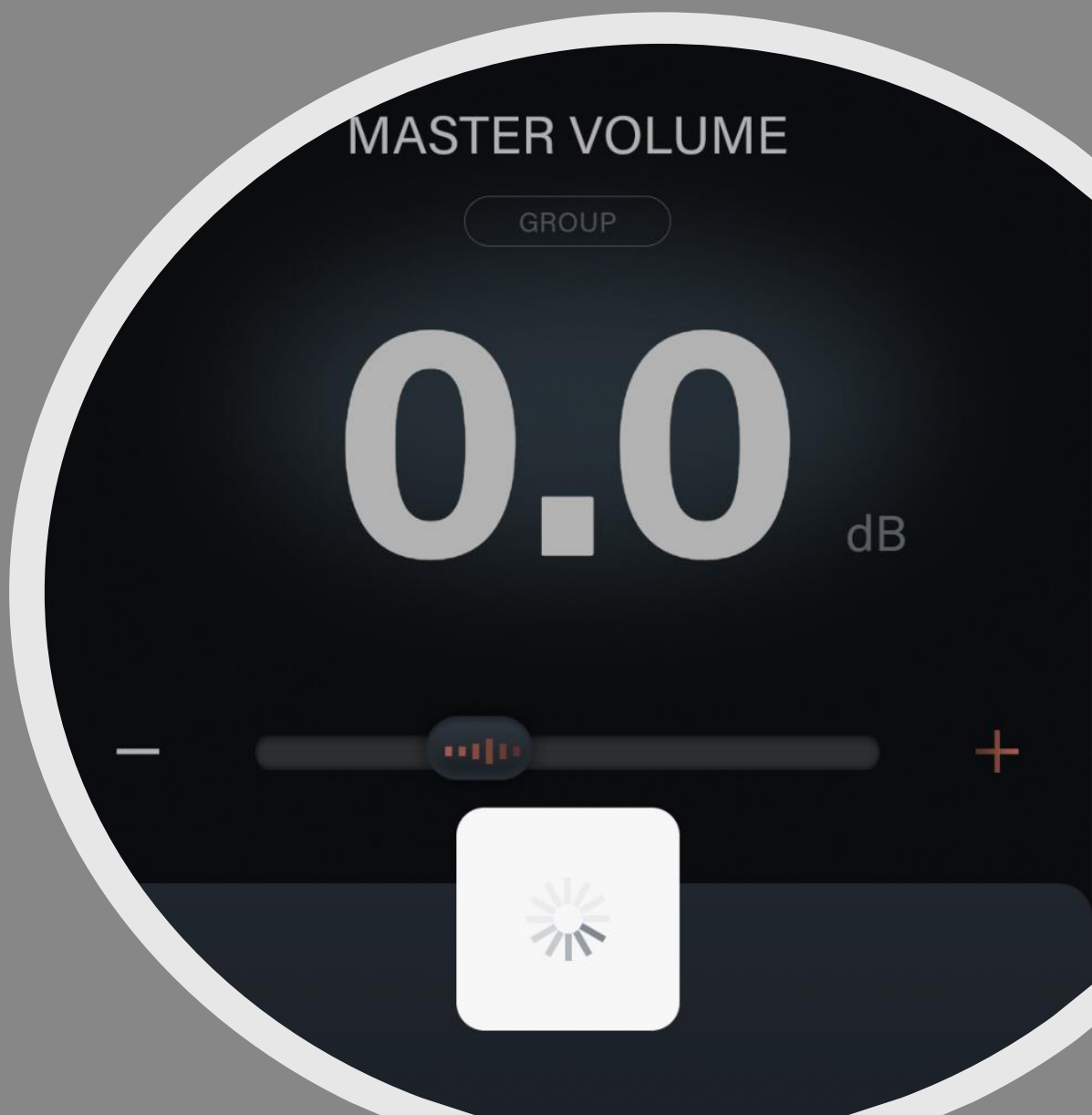

Main Page

After connection, all subwoofers available will be populated and shown in the menu. Up to 8 Perlisten Subwoofers can be controlled. The settings of each subwoofer are uploaded from the subwoofers' memory upon first connection. You will now be able to select each subwoofer individually and see the initial settings. As you make changes in the app the subwoofers will be updated in real time. This will allow you to hear the differences of audible settings immediately.

If no subs are found ensure the subs are powered on and you are near the subwoofers. Place a finger in the center of the app screen and drag down to refresh the app and it will search again for the subwoofers available.

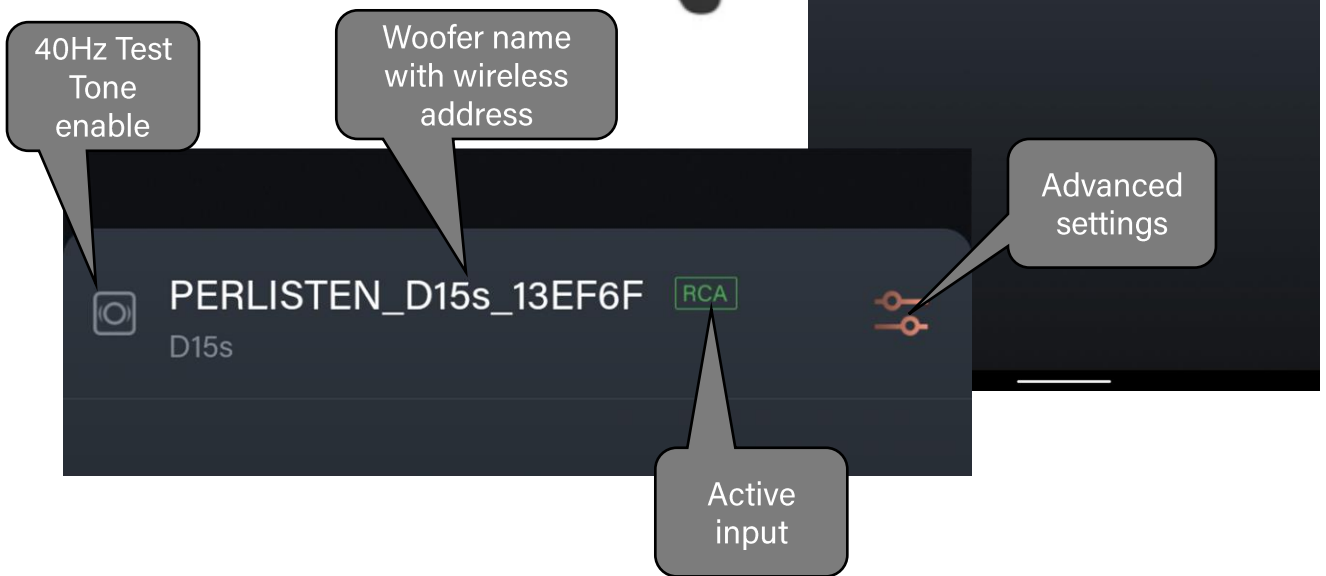

The Master level adjustment range is from -20dB to +10dB. Please note that for master levels below -10dB it is recommended to use your pre-pro's subwoofer/LFE gain first to try and achieve the desired level, then if additional cut is needed use the master level to further refine this.

The main page of the App has a default screen that allows user access to key metrics and change the master volume level for all woofers in the system equally. A key tool in allowing quick level change of the bass for music or cinema preferences. Highlighted above are the key icons to alert you the status of each subwoofer. With a glance you can tell which inputs are being used, which subwoofer input is active, do a quick test tone for setup, and enter advanced settings for each woofer.

Tapping the name allows the user to change the name of the woofer to anything desired for easy differentiation of each sub. An example could be "front left subwoofer" and "back right subwoofer" for example.

Advanced settings

Advanced settings with app screen pictures will be detailed next.

Default settings

The subwoofer will default to no crossover, delay, phase, or polarity adjustments to allow for full control from your LFE processor. This ensures your signal processor has no unexpected settings from the subwoofer itself.

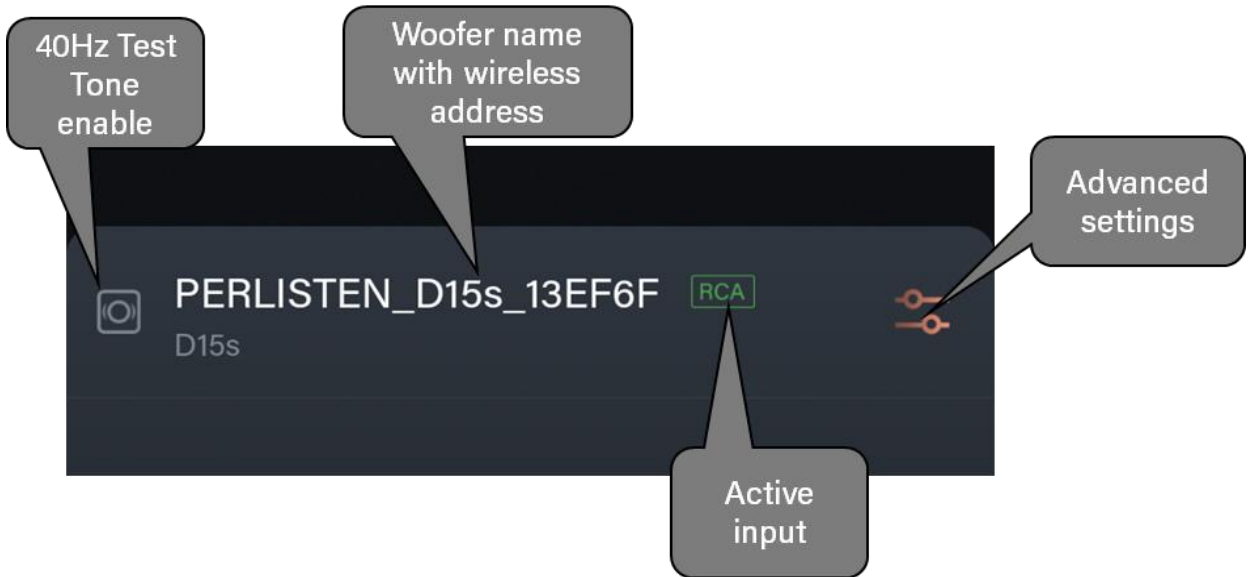

After hitting the “**Advanced**” settings button located to the right of each subwoofer you can then adjust the specific setting for that individual woofer. The menu options will be listed at the top of the new advanced setting page and as you select each title more options will slide left at the top of your screen to show all available menus. **EQ mode, Trim, Crossover, PEQ, Input Control** and **Setup** are the titles for each menu.

EQ Mode

THX EQ- This is the default EQ setting for THX with a 24dB per octave Butterworth slope with a -6dB F6 @ 20Hz. This setting is the best starting point for most installs with great frequency extension while still allowing great dynamic range.

EQ Small room- Overall, if you are using room correction this is the suggested EQ setting, as no additional factory EQ's are set and is the natural response of the woofer in its enclosure. This offers the maximum dynamic range for room correction software to adjust the performance of your subwoofer.

EQ Large room- Offers the frequency extension needed for larger rooms with less acoustic gain from nearby boundaries.

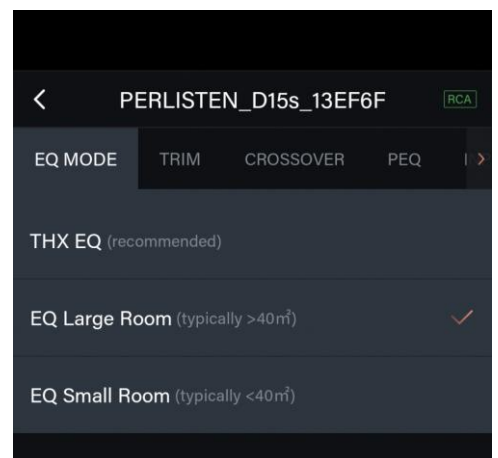

Trim

Trim is used to adjust each subwoofers individual level. For multiple subwoofers this allows slight adjustments due to the subwoofers position in the room and is limited +/-3dB in adjustment to prevent drastic changes in gain of any single subwoofer in the system. The limited adjustment ensures all subwoofers reach maximum output controlled by the master level near simultaneously before reaching a high distortion scenario.

Crossover

The cross over menu has options for Low pass filter, Phase, time delay, and polarity.

Low Pass filter - the filter can be tuned on or off with slope values from 6-24dB per octave, and frequency roll off of 30-160Hz.

Phase- Phase from 0-180 degrees can be chosen to match your subwoofer position with the main speakers at the cross over position.

Time Delay- Time delay adjustments from 0-100mS are possible to for proper time alignment of the low frequencies. If possible, using a microphone and measurement system is the best method to make sure the proper time delay is chosen between the subwoofer and main speakers.

Polarity - Polarity of "positive" or "negative" are possible.

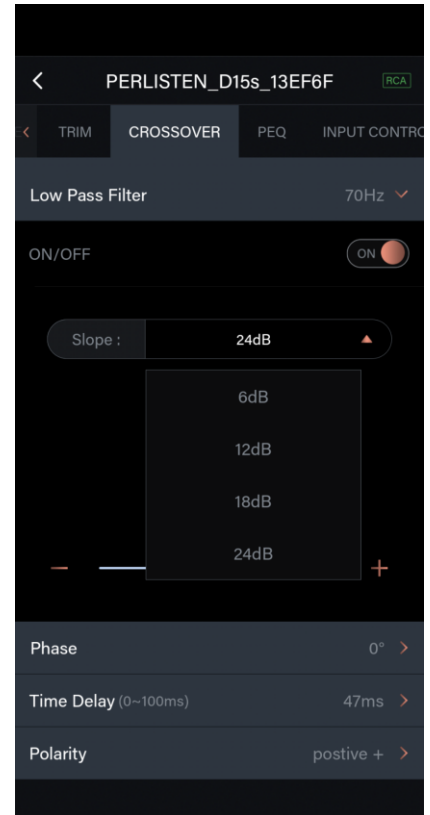

PEQ settings

When first coming to the **PEQ** menu the App will take a few seconds to download the current settings in the subwoofer you are working with. After the current settings are downloaded you are free to make adjustments per your desired response. The real power of these setting is when you take measurements of the subwoofer at the multiple listening positions and average them together with a measurement microphone and a program such programs as REW. REW(Room EQ Wizard) is a free program that has will create the correct PEQ setting to equalize your room. REW has all possible PEQ limits for Perlisten subwoofers and the suggested settings can be entered directly into our app to create the best response in your room.

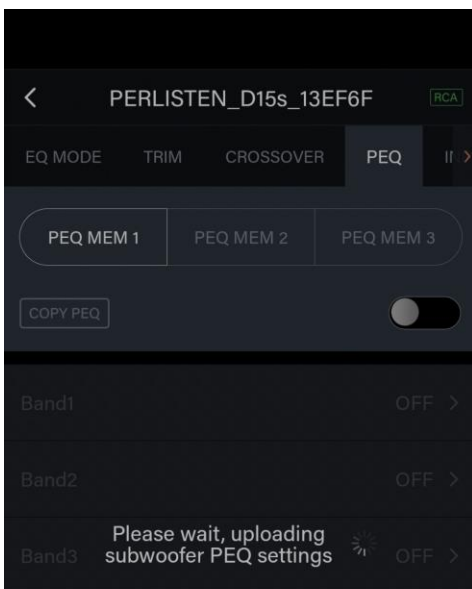

Up to 3 **PEQ Memory** banks can be used for each subwoofer and in each bank are 10 individual PEQ bands. You can turn on as few or as many PEQ's as needed to achieve the target response.

Each band has frequency adjustments from 16Hz-200Hz, Q from .3-20, and gain from -20dB to +3dB. This should allow plenty of flexibility to tune any environment.

Finally, the ability to copy the PEQ setting to another subwoofer in the system can easily be done with the **COPY PEQ** button just under the PEQ memory bar.

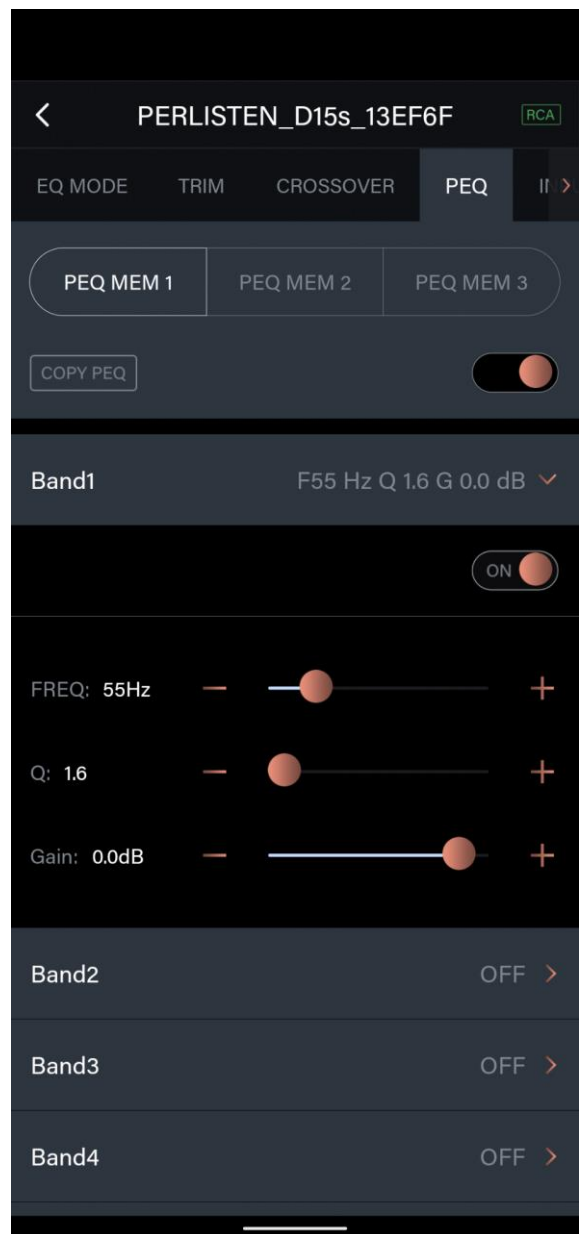
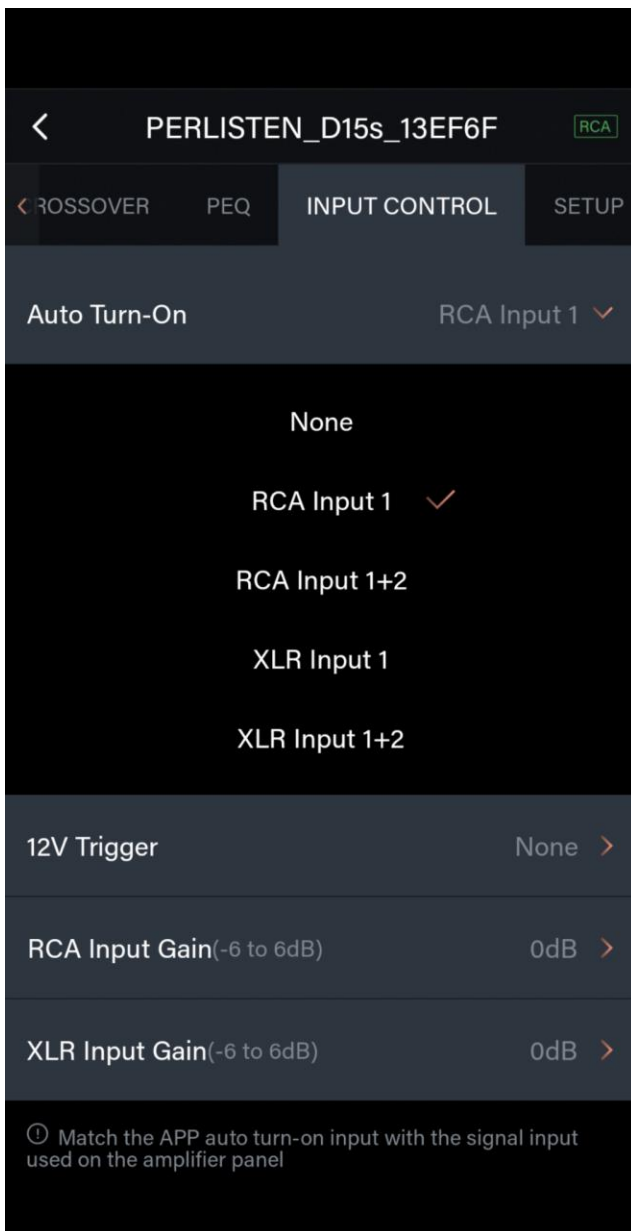

Input Control

Input control allows settings of the Auto turn on, 12v trigger, RCA input Gain, and XLR input gain.

Auto turn on can be selected for each input of RCA 1, RCA 1+2, XLR 1, and XLR 1+2. The setting will work in unison with the 12v control. Only one or the other input, RCA or XLR, can be selected for signal sensing or 12v trigger. The app will not allow you to select an input for 12v trigger if it is already set to signal sensing. This prevents mistakes or contention.

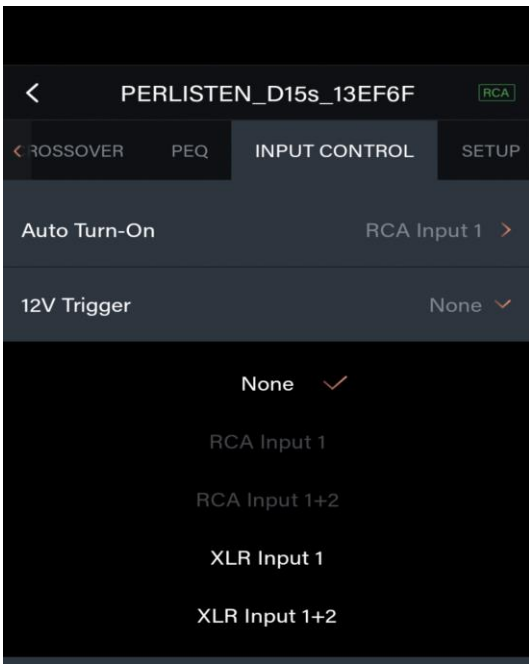

At left as discussed in the signal sensing previously, only the inputs available will be highlighted and allowed. The **12v trigger** settings in this example are only available for the XLR inputs as the signal sensing was set for the RCA inputs.

		Maximum Input Voltage	
		RCA	XLR
input gain	-6dB	8Vrms	16Vrms
	0dB	4Vrms	8Vrms
	+6dB	2Vrms	4Vrms

Pictured below, the **RCA gain** and **XLR gain** can be adjusted for -6dB, 0dB or +6dB of gain to allow for different input levels from your processor. This gain is digital gain after the ADC conversion and will not increase noise in the system. Overall, this setting is used to maximize the dynamic range into the ADC subwoofer input. The RCA inputs can handle up to 8Vrms and the XLR inputs can handle 16Vrms without distortion.

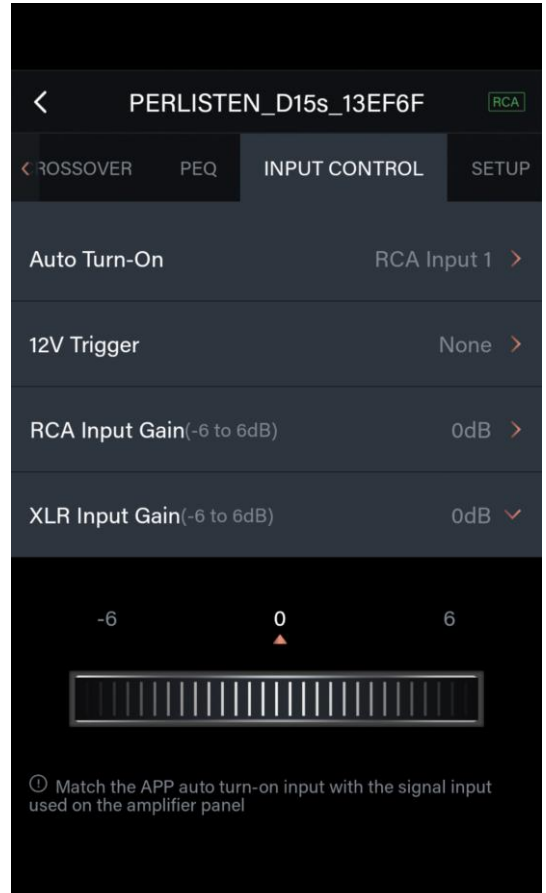
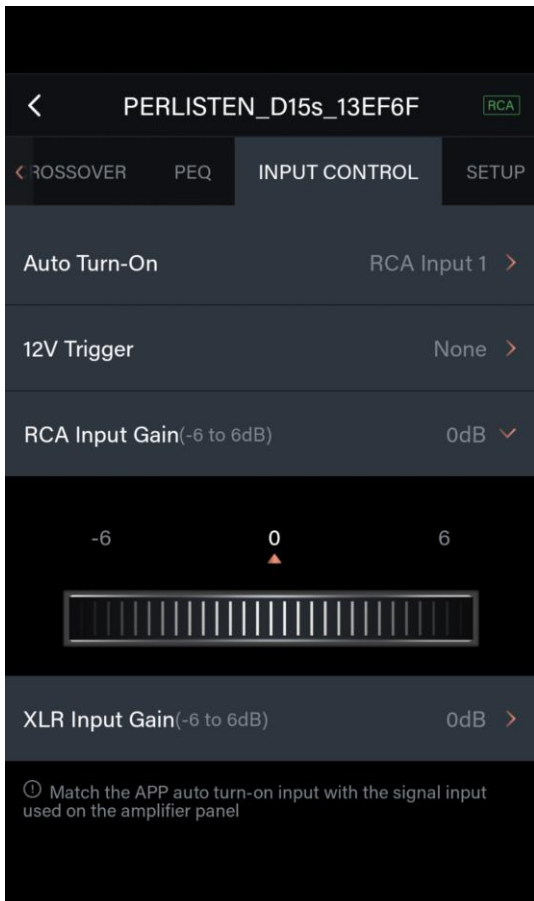

ⓘ Match the APP auto turn-on input with the signal input used on the amplifier panel

ⓘ Match the APP auto turn-on input with the signal input used on the amplifier panel

Setup Menu

The setup menu consists of the on time, turn-on sensitivity, LCD backlight, firmware version, and the ability to reset all settings to default.

The **on time** displayed on the left, is the delay time from when the subwoofer no longer has any signal at its inputs until the subwoofer shuts off. This can be set from 5 minutes to 60 minutes depending on the preferred delay.

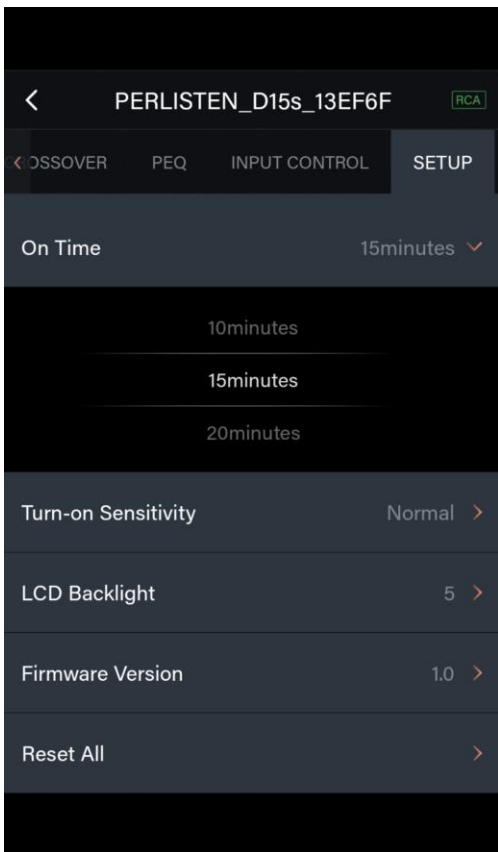

Turn on sensitivity allows adjustment of the signal sensing no matter the level of input from the processor. This allows consistent turn on no matter the source and can be set to low, normal, and high. High sensitivity would be the setting for the lowest level of signal input to turn on the subwoofer while High would be a higher level of input needed to trigger the subwoofer to turn on.

The **LCD backlight** can be set from 1-10 with 1 being the lowest setting and 10 being the highest brightness level.

Firmware version is displayed for easy reference and can be useful for the Perlisten team if diagnostics are needed when talking with customer support. Support@perlistenaudio.com can be contacted if issues arise.

Reset allows all settings to be set back to default **except the critical PEQ settings**. This is intentional as the settings can take hours of work to set properly for each position and will be saved.

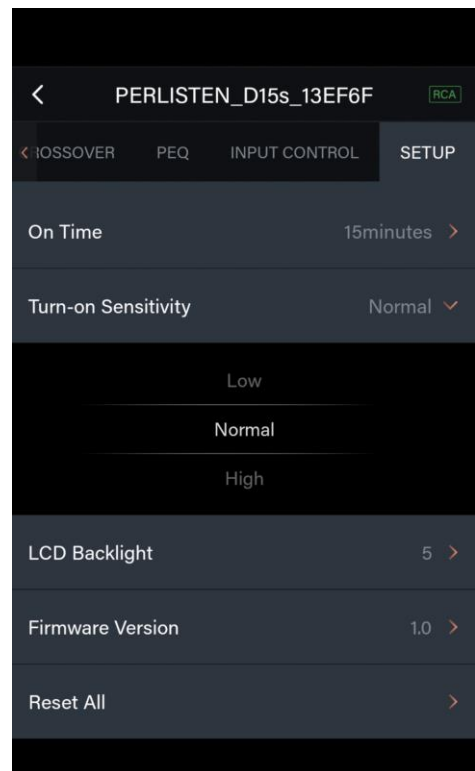

A final note about settings: after changes to any settings do not power off the amplifier for at least 15 seconds. The changed settings are saved in the subwoofer's memory every 10 seconds. This will allow the settings to be saved and not lost.



Perlisten Audio
807 Liberty drive, Suite #111
Verona, WI 53593
USA
1-414-895-6009
www.perlistenaudio.com
support@perlistenaudio.com