

MATRIX AUDIO

矩声®



element i2  
Music Streamer

| User Manual

<b>Packing list</b> . . . . .	<b>01</b>
<b>Parts and names</b> . . . . .	<b>02</b>
Front . . . . .	02
LCD Screen . . . . .	02
Rear . . . . .	03
Remote control . . . . .	04
<b>Operations before using</b> . . . . .	<b>05</b>
Connect to network . . . . .	05
MA Remote App . . . . .	05
Driver for USB Audio . . . . .	06
<b>Appendix</b> . . . . .	<b>08</b>
Technical specifications . . . . .	08
Power specifications . . . . .	09
Other specifications . . . . .	10
About MQA . . . . .	10
About Room Ready . . . . .	10
About Spotify . . . . .	10

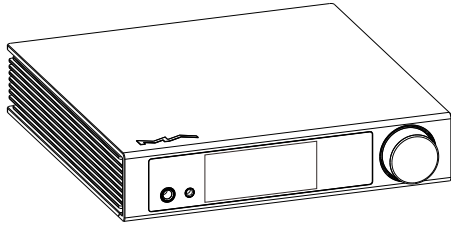

Product

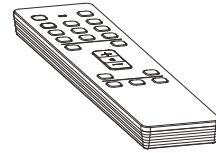

Remote control

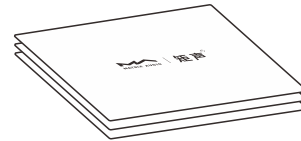

Quick start guide, warranty card

## Front

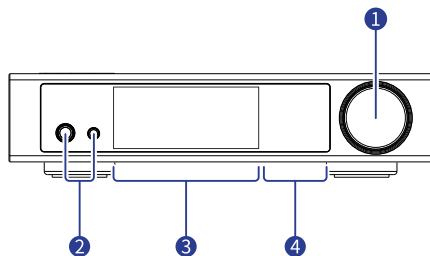

### 1 Power on/Standby button and knob

After connecting to power supply, press the knob to power on the unit, press it again to let the unit standby. It takes about 30 seconds for the first start up after each connection to the power supply. Set the output volume by turning the knob, when the "Lineout Mode" is set to Fixed through MA Remote App, the line output volume is not adjustable. Under mute mode, turn the knob to unmute.

### 2 Headphone jack

The 6.35 mm headphone jack is for single-ended headphones, the 4.4 mm headphone jack is for balanced headphones.

### 3 LCD screen

### 4 Playback touch control area

## LCD screen

## Display information



### 1 Media and audio information

Including album art, track title, artist, duration, audio format, sampling rate of the track and the filter type being used.

### 2 Input channel

The name of selected input channel.

### 3 Status

Including status of clock, network connection, USB storage, NAS and Async/Sync mode.

### 4 Output channel and volume

The selected output channel and volume level.

## Operation of touch screen



Swipe right to open the shortcut page.

Swipe left to open the menu.

## Rear

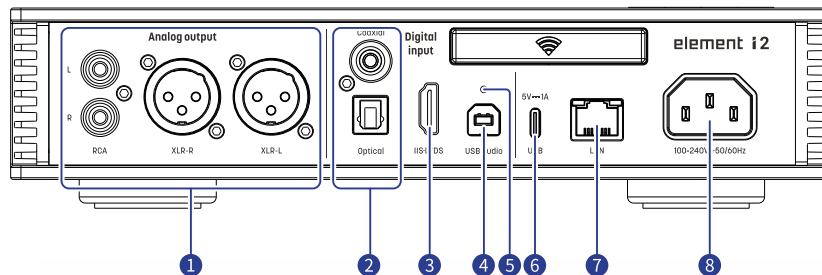
**1 Analog output**

Connect to active speakers or amplifiers through RCA or XLR cables.

**2 Optical & Coaxial input**

Connect to front-end devices with S/PDIF signal outputs through optical or coaxial cables.

**3 IIS-LVDS input**

Connect to digital interface products from Matrix Audio or other compatible devices through HDMI cables. The unit is compatible with 4 kinds of IIS-LVDS pin definitions, which can be viewed and configured in MA Remote App.

**4 USB audio input**

Connect to computers as an external audio device through USB Type B cables.

**5 Reset button**

Only use this button when the unit works incorrectly, the unit can be reset to factory state. Please operate under the instructions by service team from Matrix Audio.

**6 USB Type C**

Connect to USB storage devices which requires not higher than 5V/1A power supply.

**7 Ethernet**

Connect to LAN port of the network router, the connection supports up to Gigabit Ethernet transmission.

**8 AC input**

This unit adapt to AC100-120V and AC220-240V power supply automatically, please make sure to use the product in the power voltage range mentioned above.

\* Please use the power cable which includes an earth wire. Please ensure you have a reliable earth wire connection. Otherwise, the casing of the unit may have a slightly charged touch. If you need the unit to be turned off completely, please unplug the power cable.

## Remote control

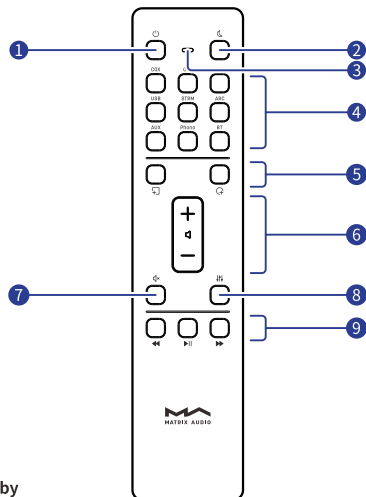

## 1 Power on/Standby

## 2 Dimmer

## 3 Working/Battery status

## 4 Input channels

\*Some are reserved.

## 5 Programmable buttons

Define the functionalities of buttons through MA Remote App, they are not defined by default.

## 6 Volume

## 7 Mute/Unmute

Press to mute, again to unmute. You also can unmute by pressing the +/- buttons in mute state.

## 8 Filters

Switch the corresponding filter types applied to the current playing audio format in a loop.

## 9 Playback control area

When the input channel supports, the playback can be controlled by these buttons.

Slide in the direction of the arrow to open the battery holder. Please pay attention to the polarity when installing the batteries.

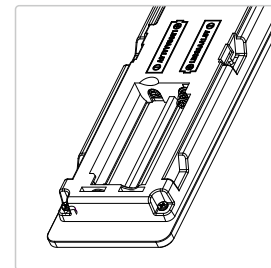
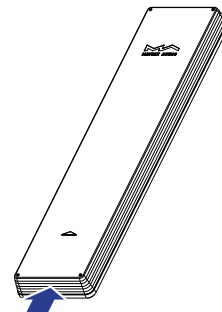

Point the remote control to the element device when using it, the operating distance is about 8 meters. When the battery is low, the LED indicator on the remote control flashes red, there will also be a notification showing on the device screen.

If there are more than one Matrix Audio device in a single environment, in order to prevent 1 remote control from controlling multiple devices at the same time, we preset 5 address codes in the remote control, these address codes can be configured in the Settings menu showing below, and follow the instructions on the screen.

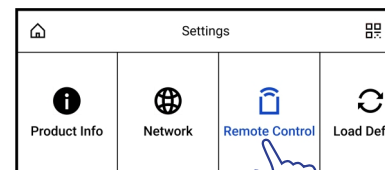

## Connect to network

### LAN

Connect the product to the LAN port of the network router through an Ethernet cable. It is recommended to set up the router as a DHCP server, the unit will be assigned an IP address automatically. Select "LAN" in option Network in Settings menu, you can configure the network specs manually, after joining the network, there will be a  shown in the status bar.

### Wi-Fi

Enter Settings menu - Network - Wi-Fi, after network scanning complete, choose the SSID of your network and enter the passwords, there will be a  shown in the status bar after connected. The device supports 2.4GHz/5GHz wireless network.

When the connection has no Internet access, there will be a  in the status bar.

## MA Remote App

Install MA Remote App for your iPad, iPhone or Android phone.



Open the app, follow the instructions to add the device to MA Remote App.

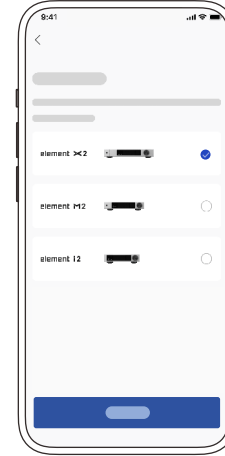

To control and configure the element device through MA Remote App, or playback streaming music from the element devices, please refer to [matrix-digi.com/tutorials](http://matrix-digi.com/tutorials) for instructions.



Tutorial Video

## Driver for USB Audio

When connecting the device to a Windows 7/8/10/11 computer via USB connection as an external audio device, please install drivers as following instructions:

1. Double-click the driver installation package and click "Next".

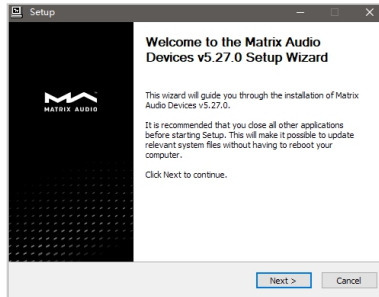

2. Select installation path and click "Install".

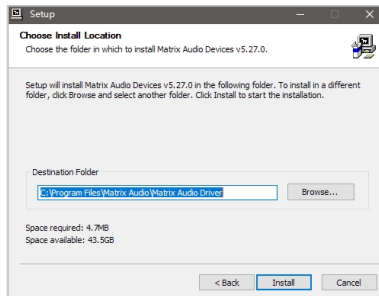

3. Click "Next" after the installation is complete.

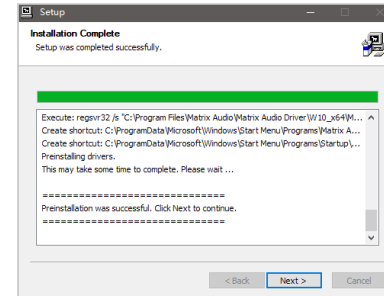

4. Click "Finish" to close the Setup Wizard.

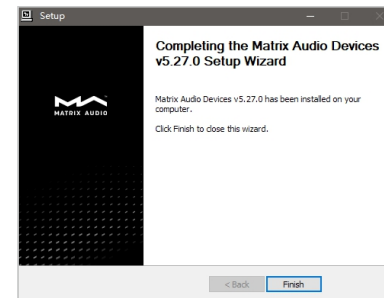



It's no need to install drivers for macOS, just select “element Series” as the audio output device in Sound Preferences.

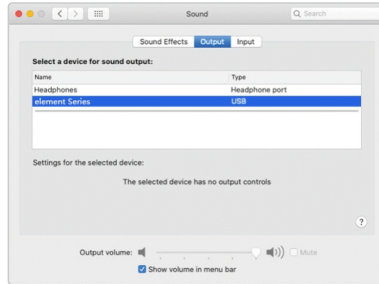

The device can be connected to an iPhone or iPad via a Lightning to USB Camera Adapter.

The device can be connected to Android devices via an OTG adapter, but not every Android device is compatible with device via OTG connection.

## Technical specifications

### Hardware Platform

CPU : NXP i.MX 6Quad Cortex-A9  
 D/A Chip : ES9038Q2M  
 Clock Source : Crystek CCHD-950

### Digital Input

#### Coaxial & Optical:

PCM 16-24Bit/44.1kHz, 48kHz, 88.2kHz, 96kHz, 176.4kHz, 192kHz  
 DSD 2.8MHz (DoP)

#### IIS-LVDS:

PCM 16-32Bit/44.1kHz, 48kHz, 88.2kHz, 96kHz, 176.4kHz,  
 192kHz, 352.8kHz, 384kHz, 705.6kHz, 768kHz  
 DSD 2.8MHz, 5.6MHz, 11.2MHz (DoP)  
 DSD 2.8MHz, 5.6MHz, 11.2MHz, 22.4MHz (Native)

#### USB Audio:

PCM 16-24Bit/44.1kHz, 48kHz, 88.2kHz, 96kHz, 176.4kHz,  
 192kHz, 352.8kHz, 384kHz, 705.6kHz, 768kHz  
 MQA 16-24Bit/44.1kHz, 48kHz, 88.2kHz, 96kHz, 176.4kHz,  
 192kHz, 352.8kHz, 384kHz MQA or MQA Studio stream  
 DSD 2.8MHz, 5.6MHz, 11.2MHz (DoP)  
 DSD 2.8MHz, 5.6MHz, 11.2MHz, 22.4MHz (Native)

### Line Output

#### XLR

SNR : > -120dB A-weighting  
 THD+N : <0.00025%@1k, <0.00035%@20Hz-20kHz  
 Frequency Response : 20Hz-20kHz  $\pm 0.1$  -3dB@80kHz  
 Crosstalk : >-138dB  
 Output Level : 4VRMS@0dB

#### RCA

SNR : > -118dB A-weighting  
 THD+N : <0.00035%@1k, <0.00050%@20Hz-20kHz  
 Frequency Response : 20Hz-20kHz  $\pm 0.1$  -3dB@80kHz  
 Channel Crosstalk : >-130dB  
 Output Level : 2VRMS@0dB

### Headphone Output

#### 4.4mm Balanced

SNR : >-116dB A-weighting  
 THD+N : <0.0006%@20Hz-20kHz 4VRMS  
 Frequency Response : 20Hz-20kHz  $\pm 0.1$  -3dB@65kHz  
 Output Impedance : <22 $\Omega$   
 Output Power : 1500mW@33 $\Omega$ , 950mW@300 $\Omega$ , 500mW@600 $\Omega$ , 1%THD  
 Gain : +16.5dB

#### 6.35mm Single-ended

SNR : >-114dB A-weighting  
 THD+N : <0.0008%@20Hz-20kHz 2VRMS  
 Frequency Response : 20Hz-20kHz  $\pm 0.1$  -3dB@65kHz  
 Output Impedance : <11 $\Omega$   
 Output Power : 1200mW@33 $\Omega$ , 260mW@300 $\Omega$ , 130mW@600 $\Omega$ , 1%THD  
 Gain : +16.5dB

### Network

LAN : 10/100/1000 Mbps  
 WLAN : 2.4GHz/5Ghz

## USB

The USB port provides a maximum power of 5V/1A.

\* The USB port works with devices which conform to the USB mass storage standard and supports FAT, FAT32, exFAT, and NTFS file formats, but is not guaranteed to be compatible with all storage devices.

## MA Player

Controller app : MA Remote App

### Local Playback:

Format Supported : MP3 , WMA , WAV , AIF, AIFC, AIFF, AAC, FLAC, OGG, APE, ALAC, M4A, DSF, DFF, CUE

PCM 16-24Bit/44.1kHz, 48kHz, 88.2kHz, 96kHz, 176.4kHz, 192kHz, 352.8kHz, 384kHz, 705.6kHz, 768kHz

MQA 16-24Bit/44.1kHz, 48kHz, 88.2kHz, 96kHz, 176.4kHz, 192kHz, 352.8kHz, 384kHz MQA or MQA Studio stream

DSD 2.8MHz, 5.6MHz, 11.2MHz, 22.4MHz

Room Ready:

PCM 16-24 Bit/44.1kHz, 48kHz, 88.2kHz, 96kHz, 176.4kHz, 192kHz, 352.8kHz, 384kHz, 705.6kHz, 768kHz

MQA 16-24 Bit/44.1kHz, 48kHz, 88.2kHz, 96kHz, 176.4kHz, 192kHz, 352.8kHz, 384kHz MQA or MQA Studio stream

DSD 2.8MHz, 5.6MHz, 11.2MHz, 22.4MHz

AirPlay 2, DLNA/UPnP, TIDAL Connect, Spotify Connect, vTuner, the audio specs depend on the service provide.

## Power specifications

Power Voltage : AC 100V-240V 50/60Hz

Standby Power Consumption : < 5W

Maximum Power Consumption : < 30W

## Other specifications

Weight : 2.6 kg (5.73pounds)

Size : Width 240 mm (9.45 inches),

Depth 259 mm (10.20 inches),

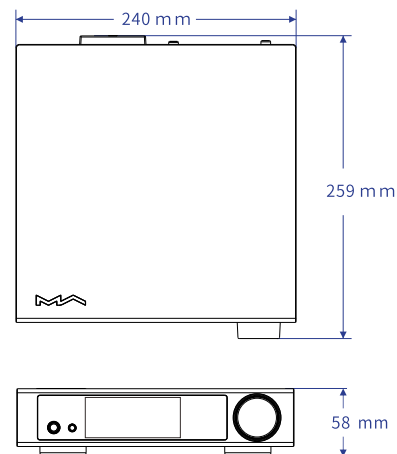

Height 58 mm (2.28 inches).



\*Specifications are subject to change without notice.

## About MQA (Master Quality Authenticated)

This unit includes a MQA full decoder, which enables you to playback MQA audio files via streaming or USB audio port, delivering the sound of the original master recording.

The dots beside the MQA logo green MQA or blue  to indicate that the unit is decoding and playing an MQA stream or file, and denotes provenance to ensure that the sound is identical to that of the source material. It glows blue  to indicate it is playing an MQA Studio file, which has either been approved in the studio by the artist/producer or has been verified by the copyright owner.

The dot glows magenta  to indicate that the unit is rendering an MQA stream or file. This delivers the final unfold of the MQA file.

\*MQA and the Sound Wave Device are registered trade marks of MQA Limited. ©2016

## About Roon Ready

Being Roon Ready means that Matrix Audio music streamers transparently discover and connect to Roon without any configuration, and bit-perfect audio is delivered from Roon to your music streamers.

## About Spotify

Use your phone, tablet or computer as a remote control for Spotify. Go to [spotify.com/connect](https://spotify.com/connect) to learn how.

The Spotify Software is subject to third party licenses found here:

<https://www.spotify.com/connect/third-party-licenses>.

- This product is for indoor use only.
- For full ventilation, it is recommended to reserve a space of larger than 5 cm around the device.
- Do not cover the air vents with stuffs such as papers, tablecloths, and curtains to obstruct ventilation.
- Do not place stuff with flame, such as lighted candles, on the device.
- If the device is used in tropical areas, please be careful to prevent insects from entering the unit through the air vents.
- The device must not be subject to water droplets or splashes. Please do not place stuffs filled with liquids such as vases and cups on or near the device.
- Do not put stuffs around the device power plug and the AC power socket, in order to disconnect the power supply easily when needed.

# HIGH PERFORMANCE AUDIO

[www.matrix-digi.com](http://www.matrix-digi.com)

Matrix Electronic Technology Co., LTD  
+86-29-86211122  
B-801, No.111 Fengcheng 5th Rd.,  
Xi'an, China

